

# Design of a Photovoltaic Powered Forced Convection Solar Dryer in NEH Region of India

Mahendra S. Seveda\*<sup>‡</sup>

\* College of Agricultural Engineering and Post Harvest Technology

(seveda\_mahendra@rediffmail.com)

<sup>‡</sup> Corresponding Author; Mahendra S. Seveda, Central Agricultural University, Ranipool, Gangtok-737135, Sikkim, India, +91 3592 251556, seveda\_mahendra@rediffmail.com

*Received: 27.10.2013 Accepted: 18.11.2013*

**Abstract-** A low cost photovoltaic powered forced convection solar dryer was developed and evaluated for drying of Chilli in the conditions of NEH region of India. The PV powered forced convection solar dryer consists of solar PV module of area (280×230) mm<sup>2</sup> connected with drying chamber. The solar panel is tilted to an angle of 45° with respect to horizontal. It was connected to the exhaust fan provided at the opposite wall of the dryer with the help of electric wire. The drying chamber was made up of M.S. angle, G.I. sheet and glazing material with the frame size of (700×700) mm<sup>2</sup>, opposite wall size of (700×700) mm<sup>2</sup> and front side size of (890×700) mm<sup>2</sup> with the inclination of 45°. The two drying trays were contained inside the drying chamber which is made up of aluminium angle, aluminium strip and steel wire mesh. The lower and upper tray was fitted at the height of 150 mm and 350 mm from the base of the dryer. The size of lower and upper tray was (680×490) mm<sup>2</sup> and (680×270) mm<sup>2</sup>. Air inlet is provided in the one fourth area of the base with the diameter of 600 mm. The drying chamber is insulated with thermocole of 10 mm thickness. At the one side of the dryer an insulated door is provided to facilitate the loading and unloading of the trays. The dryer was capable of holding about 6 kg of chillies per batch. Average air temperature attained in the solar dryer was about 40°C higher than the ambient temperature. Drying of chilli in a PV powered forced convection solar dryer reduces the moisture content from around 80.2% (wet basis) to the final moisture content about 10.00% in 32 h.

**Keywords-** Solar dryer, forced convection, drying rate, chilli drying.

## 1. Introduction

Drying is an essential process used all over the world for the preservation of farm produce. It helps in reducing the water activity of the produce to a level below which deterioration does not occur for a definite duration. Sun drying is still widely used in many tropical and subtropical countries [1]. Sun drying is the cheapest method, but the quality of the dried products is far below the international standards. Improvement of product quality and reduction of losses can only be achieved by the introduction of suitable drying technologies [2]. However, this method of drying is extremely weather dependent and has the problems of contamination, infestation, microbial attacks, etc., thus affecting the product quality. The rate of drying depends on various parameters such as solar radiation, ambient temperature, wind velocity, relative humidity and initial

moisture content, type of crops, crop absorptivity and mass of product per unit exposed area. This form of drying has many drawbacks such as degradation by wind, blown, debris, rain and insect infestation, human and animal interference that will result in contamination of the product [3]. Drying rate will reduce due to intermittent sunshine, interruption and wetting by rain.

Solar drying is a well-known food preservation procedure used to reduce the moisture content of agricultural products, which reduces quality degradation over an extended storage period. Several Solar crop dryers are a viable alternate to open sun drying, and have several advantages. They offer better quality dried products as the products are protected; drying time is also significantly reduced. Several types of solar dryers have been developed and used to dry a variety of agricultural product. Solar dryers

using natural convection or forced circulation have been investigated to overcome these problems [4]. For commercial applications, the ability of the dryer to process continuously throughout the day is very important to dry the products to its safe storage level and to maintain the quality [5].

Solar dryers may be classified according to the mode of air flow as natural convection and forced convection dryers. Natural convection dryers do not require a fan to blow the air through the dryer. Solar drying may also be classified into direct, indirect and mixed-modes. In direct solar dryers the air heater contains the materials and solar energy passes through a transparent cover and is absorbed by the materials. Essentially, the heat required for drying is provided by radiation to the upper layers and subsequent conduction into the material bed. In indirect dryers, solar energy is collected in a separate solar collector (air heater) and the heated air then passes through the material bed, while in the mixed-mode type of dryer, the heated air from a separate solar collector is passed through a material bed and at the same time, the drying cabinet or chamber absorbs solar energy directly through the transparent walls or roof [6].

Active solar dryer are also called force convection solar dryer. It is generally agreed that forced convection distributed solar dryer are more effective and more controllable than the natural-circulation type. External force is provided to the solar dryer such as fans may be powered with utility electricity if available, or with a solar photovoltaic panel [7]. In a solar photovoltaic powered, fan is directly coupled to the solar module increasing the solar radiation increase the module's output, thus speeding up the fan.

Chilli is one of the most important commercial crops of India. It is grown almost throughout the country. There are more than 400 different varieties of chillies found all over the world. It is also called as *hot pepper*, *cayenne pepper*, *sweet pepper*, *bell pepper*, etc. Its botanical name is "*Capsicum annum*". The world's hottest chilli "Naga Jolokia" is cultivated in hilly terrain of Assam in a small town Tezpur, India. India is the largest producer of chilli and annually production is around 1.1 million tones. India also has the maximum area dedicated to the production of this crop. Chilli is a universal spice of India [8]. It is cultivated in all states and union territories of the country. Chillies are cultivated seasonally but are consumed throughout the year. Chillies are grown on soils with light sands to well drained clay [9]. Silty and clay loam soils are better, while water-logged and alkali is not suitable. In Indian subcontinent, chillies are produced throughout the year [10]. Two crops are produced in kharif and rabi seasons in the country. Chilli grows best at 20–30°C. Growth and yields suffer when temperatures exceed 30°C or drops below 15°C for extended periods. Chilli is normally dried on open ground with no shelter provided. It is common to see rooftops covered with chilli during the summer months. This practice results in poor final quality associated with huge financial losses to the poor farmers.

## 2. Materials and Methods

### 2.1. Working Principle of Photovoltaic Powered Forced Convection Solar Dryer

This dryer was designed to make use of solar energy during day time. As the solar radiations falls on the glass surface some of incidence solar radiation is reflected back to atmosphere and remaining enter inside the dryer, the thermocole sheet inside the solar dryer was black painted to absorb the incident solar radiation. Solar radiation gets absorbed by the produce and inside drying chamber, resulting in an increase of dryer temperature [11]. This process produces temperature difference between the inside and outside cabinet air. Inside the chamber, heated air pick up moisture from the product as it passes through the trays and taken away by the air entering into the drying chamber from the inlet provided at the bottom of the dryer and comes out through the outlet provided on the opposite wall of the drying chamber with the aid of the supplied PV powered dc fan.

### 2.2. Experimental Set Up

The photovoltaic powered forced convection solar dryer consists of solar panel of area (280×230) mm<sup>2</sup> connected with drying chamber. The solar panel is tilted to an angle of 45° with respect to horizontal. It was connected to the exhaust fan provided at the opposite wall of the dryer with the help of electric wire. The drying chamber was made up of M.S. angle, G.I. sheet and glazing material with the frame size of (700×700) mm<sup>2</sup>, opposite wall size of (700×700) mm<sup>2</sup> and front side size of (890×700) mm<sup>2</sup> with the inclination of 45°. The two drying trays were contained inside the drying chamber which is made up of aluminium angle, aluminium strip and steel wire mesh. The lower and upper tray was fitted at the height of 150 mm and 350 mm from the base of the dryer. The size of lower and upper tray was (680×490) mm<sup>2</sup> and (680×270) mm<sup>2</sup>. Air inlet is provided in the one fourth area of the base with the diameter of 600 mm. The drying chamber is insulated with thermocole of 10 mm thickness. At the one side of the drier an insulated door is provided to facilitate the loading and unloading of the trays. The dryer was capable of holding about 6 kg of chillies per batch. The schematic diagram of PV powered forced convection solar dryer shown in Fig. 1.

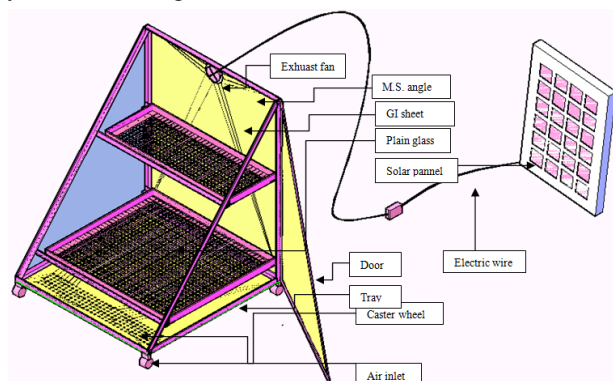

Fig. 1. Schematic diagram of Portable PV powered forced convection solar dryer

### 2.3. Construction of the photovoltaic Powered Forced Convection Solar Dryer

The materials which have been used for the construction of photovoltaic powered forced convection solar dryer for chilli drying were easily obtainable in local market.

#### 2.3.1. Frame structure

The frame structure was fabricated with the help of cutting, grinding and arc welding. The structure consisted of legs, base frame and supporting frame. M.S angle of (20 × 20 × 3) mm was used to fabricate the structure. This frame structure was mounted on four legs of 800 mm height.

#### 2.3.2. Box

The frame structure was covered with the G.I. sheet on the back, bottom and one side of the frame. Thermocole sheet were fitted on the same side with G.I. sheet for insulation. On the other side of the structure insulated door is fitted to facilitate loading and unloading of wire mesh trays containing the product to be dried.

#### 2.3.3. Insulation

Thermocole sheet was fitted for the insulation on the back, bottom and sides of the dryer, which help in reduction of heat loss for the dryer.

#### 2.3.4. Glazing

Glazed cover of plain glass is mounted on front of the frame for solar energy interception. 4mm thickness of plain glass was used.

#### 2.3.5. Drying trays

The solar dryer has two drying trays of wire mesh on base. The trays were constructed from wire mesh, aluminium angle of (25 × 25 × 3) mm and aluminium strip of (20 × 3) mm.

#### 2.3.6. Exhaust fan

DC fan fitted on opposite wall of the drying chamber which help in faster removal of moisture from produce and it also help in circulation of hot air develop inside the drying chamber due to solar energy.

#### 2.3.7. Solar panel/ module

Manufacturer by Tata BP Solar India Limited in ISO 9001 and 14001. The module has a voltage of 8.5 V, current 0.6A mp and peak power of 5.0 W.

### 2.4. Experimental procedure

Only good quality chillies were used in the experiment. 6 kg of fresh Chilli were dried until the required final moisture content was attained. The fresh chilli was located over the trays of drying chamber having about 90% perforation. The initial moisture content was calculated by taking three different samples. During the experiment moisture content was calculated at every interval of one hour during the drying hours. The exhaust fan was operated for reducing of relative humidity inside the solar dryer. The different parameters were observed during the experiment hours at every interval inside and outside the solar dryer. Open sun drying method was also conducted to know the performance of the dryer. Solar dryer was tested for its performance in drying of Chilli by conducting two sets of experiments. The tests were conducted from 08.00 to 16.00 hrs and the hourly data were recorded.

The full load test was conducted for evaluate the performance of the photovoltaic powered forced convection solar dryer in actual loading condition. The dryer contained two trays upper and lower; 4 kg of fresh chilli was placed on the upper tray and remaining in the lower tray i.e. 2 kg of fresh chilli. Loading and unloading was done manually. One kg of fresh Chilli was placed in open air for drying for comparison purpose. The observations of the parameters were recorded at interval of one hours starting from 8 hrs to 16 hrs each day. The solar insolation was measured with lux meter, the inside and outside temperature was measured with the digital thermometer and the hygrometer was used to measure relative humidity. Keeping two thermometers and hygrometer inside and one outside the observation was recorded. By using oven drying method the initial moisture content of fresh chilli was determined. The drying was continued till the moisture content of the Chilli tends to a constant value.

The performance of drying unit was evaluated in terms of moisture content variation, drying rate, etc. For this purpose, the hourly reductions in weight of representative sample were recorded.

## 3. Results and Discussion

The photovoltaic powered force convection solar dryer was developed and fabricated for small farmers and households in NEH region of India in the workshop of the College of Agricultural Engineering and Post Harvest Technology, Central Agricultural University, Ranipool, Gangtok, Sikkim. The experimental data along with input environmental parameters such as solar insolation, ambient temperature, inside temperature, relative humidity were recorded. The recorded data were analyzed to evaluate the performances.

### 3.1. Dimension of Solar Dryer

The photovoltaic powered forced convection solar dryer was designed and developed in the NEH region of India. The dimensions are given below in Table 1.

**Table 1.** Dimensions of portable PV powered forced convection solar dryer.

Components	Specifications
Aperture area	0.595 m <sup>2</sup>
Front base of solar dryer	0.7 m
Width of solar dryer	0.7 m
Nos. of trays	Two
Upper tray size	(680 × 270) mm
Lower tray size	(680×490) mm
Nos. of air inlet	50
Diameter of air outlet	6 mm
Inclination of the dryer	45°
Loading per batch	6 kg
Drying time per batch	4 days

### 3.2. System Description of the Solar Dryer

Figure 2 shows a pictorial view of photovoltaic powered forced convection solar dryer designed and developed for drying of chilli.



**Fig. 2.** Pictorial view of photovoltaic powered forced convection solar dryer

### 3.3. Performance Evaluation of Solar Dryer

The performance of solar dryer was evaluated during the month of December, 2011 for drying of chilli. The performance evaluation test includes measuring solar insolation, ambient temperature, ambient relative humidity, wind velocity, air flow rate inside the dryer, air temperature and relative humidity inside the solar tunnel dryer. During full load testing, four days are required for drying total amount of Chilli in the solar dryer from moisture content of 80.2 to 10 per cent (w.b.). The testing on full load was conducted for three consecutive days in the month of December, 2011.

#### A. Variation of temperature and solar radiation

##### a) First day of drying

During the first day of drying in the month of December, 2011, it was observed that 65 °C and 57 °C was the

maximum temperature inside the solar dryer in upper and lower tray at 14 hours respectively and the minimum temperature for the upper and lower tray was 28 °C and 24 °C at 8 hours respectively. The maximum ambient temperature was 28 °C at 14 hours while minimum was 17 °C at 8 hours respectively. It was observed that maximum solar radiation inside the dryer was 523 W/m<sup>2</sup> at 13 hours and minimum was 19 W/m<sup>2</sup> at 16 hours respectively. The maximum ambient solar radiation was 601W/m<sup>2</sup> and minimum was 43 W/m<sup>2</sup>. The trend of results is plotted on graphs as shown in Fig. 3 and 4.

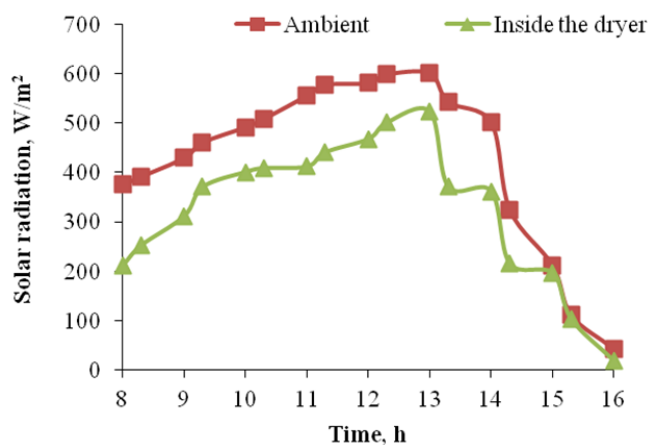

**Fig. 3.** Variation of solar radiation under full load condition in the first day of drying stage

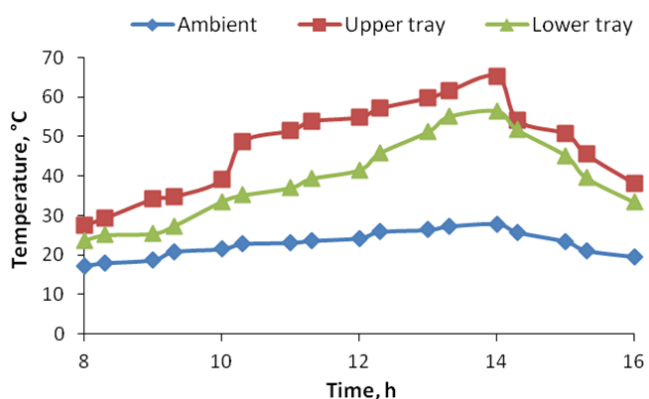

**Fig.4.** Variation of air temperature under full load condition in first day of drying stage

##### b) Second day of drying

During the second day of drying in the month of December, 2011, it was observed that 69°C and 57°C was the maximum temperature for the upper and lower tray inside the solar dryer at 14 hours respectively and the minimum temperature for the upper and lower tray was 30°C and 25°C at 8 hours respectively. The maximum ambient temperature was 28 °C at 14 hours while minimum was 17 °C at 8 hours respectively. It was observed that maximum solar radiation inside the dryer was 535 W/m<sup>2</sup> at 13 hours and minimum was 19 W/m<sup>2</sup> at 16 hours respectively. The maximum ambient solar radiation was 609W/m<sup>2</sup> and minimum was 51 W/m<sup>2</sup> respectively. The trends of results is plotted on graphs as shown in Fig. 5 and 6.

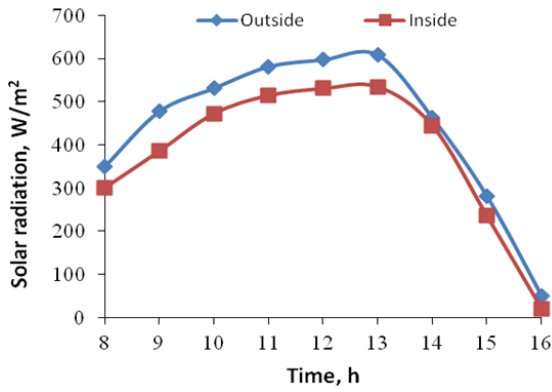

**Fig. 5.** Variation of solar radiation under full load condition in the second day of drying stage

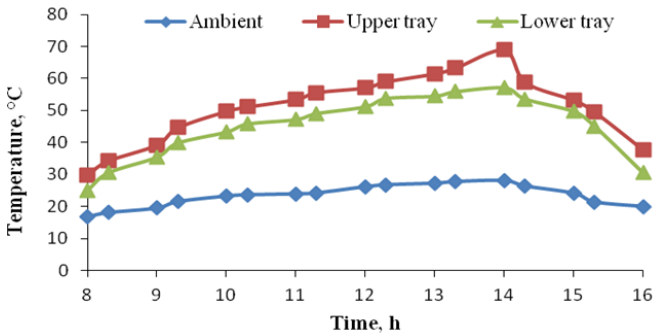

**Fig. 6.** Variation of air temperature under full load condition in second day of drying stage

*c) Third day of drying*

During the third day of drying in the month of December, 2011, it was observed that 71°C and 68°C was the maximum temperature for the upper and lower tray inside the solar dryer at 14 hours respectively and the minimum temperature for the upper and lower tray was 30°C and 24°C at 8 hours respectively. The maximum ambient temperature was 28°C at 14 hours while minimum was 16°C at 8 hours respectively. It was observed that maximum solar radiation inside the dryer was 586W/m<sup>2</sup> at 13 hours and minimum was 30 W/m<sup>2</sup> at 16 hours respectively. The maximum ambient solar radiation was 671W/m<sup>2</sup> and minimum was 65W/m<sup>2</sup> respectively. The trend of results is plotted on graph as shown in Fig. 7 and 8.

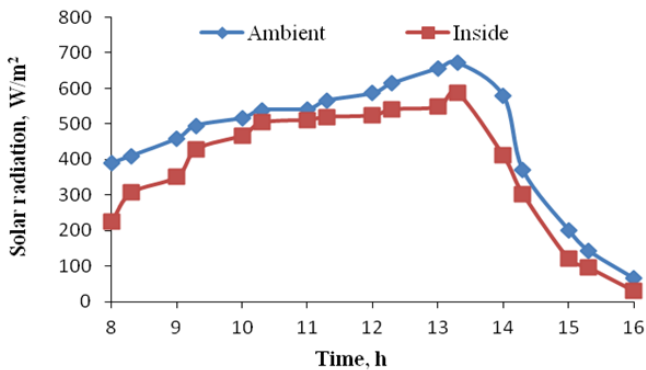

**Fig. 7.** Variation of solar radiation under full load condition in the third day of drying stage

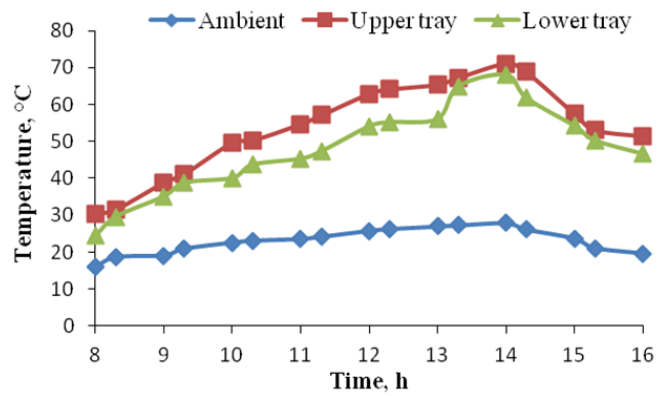

**Fig. 8.** Variation of air temperature under full load condition in third day of drying stage

*d) Fourth day of drying*

During the fourth day of drying, it was observed that 69°C and 58°C was the maximum temperature for the upper and lower tray inside the solar dryer at 14 hours respectively and the minimum temperature for the upper and lower tray was 30°C and 27°C at 8 hours respectively. The maximum ambient temperature was 29°C at 14 hours while minimum was 17°C at 8 hours respectively. It was observed that maximum solar radiation was 409 W/m<sup>2</sup> at xx hours and minimum was 19 W/m<sup>2</sup> at 16 hours respectively. The maximum ambient solar radiation was 671W/m<sup>2</sup> and minimum was 65W/m<sup>2</sup> respectively. The trend of results is plotted on graph as shown in Fig. 9 and 10.

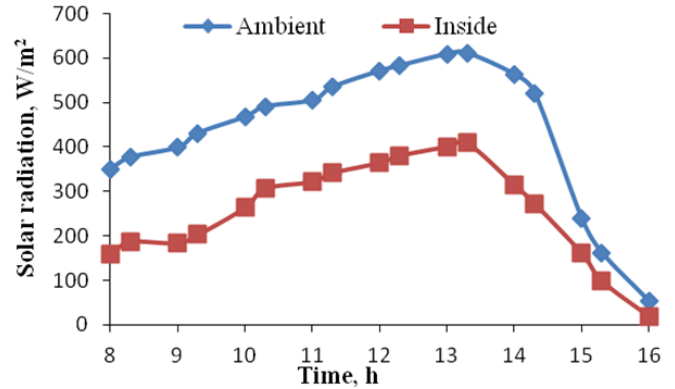

**Fig. 9.** Variation of solar radiation under full load condition in the fourth day of drying stage

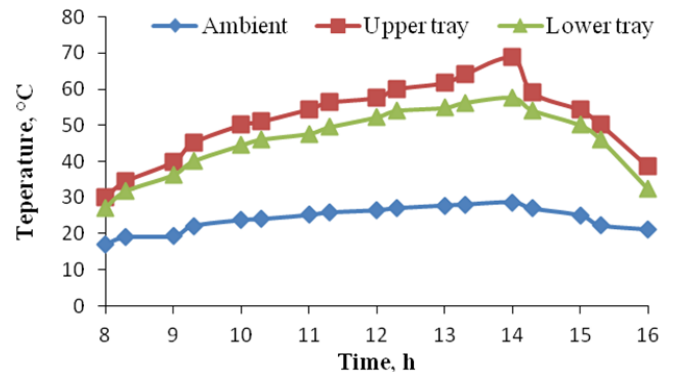
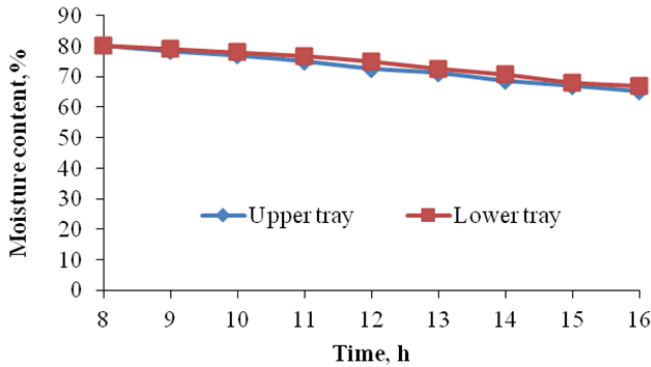

**Fig. 10.** Variation of air temperature under full load condition in fourth day of drying stage

**B. Variation of moisture content**

*a) First day of drying*

At the starting of first day the initial moisture content measured at upper and lower tray was 80.2 % and 80.2 % w.b. and at the end of the first day it was 65.1% and 67% w.b. respectively. The reduction in moisture content with time was shown in Fig. 11.



**Fig. 11.** Variation of moisture content with time in the first day of drying stage

*b) Second day of drying*

At the starting of Second day the initial moisture content measured at upper and lower tray was 64.65 % and 66.31% w.b. and at the end of the second day it was 45.1% and 47.63% w.b. respectively. The reduction in moisture content with was shown in Fig.12.

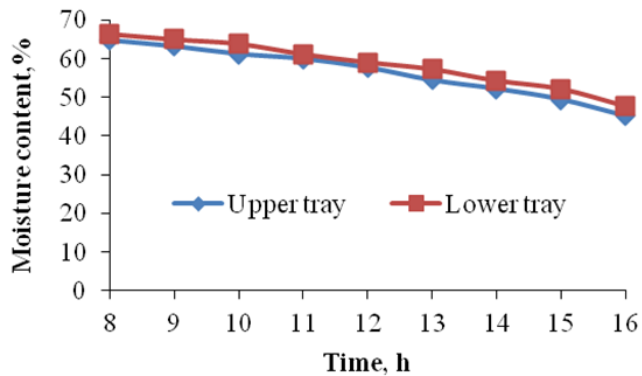

**Fig. 12.** Variation of moisture content with time in the second day of drying stage

*c) Third day of drying*

At the starting of third day the initial moisture content measured at upper and lower tray was 44.63 % and 46.11 % w.b. and at the end of the third day it was 24.1% and 26.9% w.b. respectively. The reduction in moisture content with time was shown in Fig. 13.

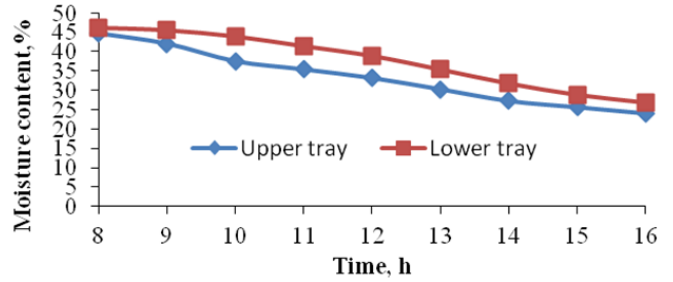

**Fig. 13.** Variation of moisture content with time in the third day of drying stage

*d) Fourth day of drying*

At the starting of fourth day the initial moisture content measured at upper and lower tray was 23.3% and 24.9% w.b. and at the end of the fourth day it was 10% and 10% w.b. respectively. The reduction in moisture in moisture content with was shown in Fig. 14.

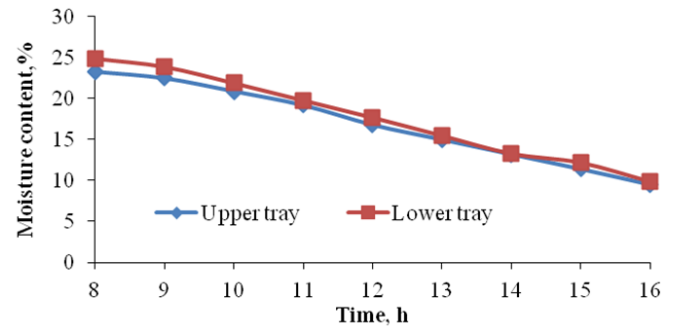

**Fig. 14.** Variation of moisture content with time in the fourth day of drying stage

**C. Variation of drying rate**

Figure 15 shows the variation of drying rate against drying time. High drying rate (of about 0.5127 kg/hr) was observed during the initial stages of drying. This is because the higher drying rate of the chilli during initial stage of drying results in release of more moisture in the drying air. Drying rate gets decreased with increase in drying time. Drying occurs in the falling rate period with steep fall in moisture content in initial stages of drying and becomes very low in the later stages.

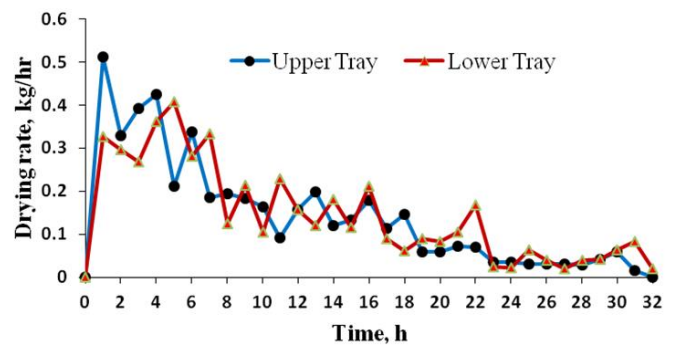

**Fig. 15.** Variation of drying rate with time

### 3.4. Open Sun Drying

It was observed that in open sun drying method the required final moisture content was attained in 56 hours of drying process. It was found that the final required moisture content was 11.9 at the end of the drying. Figure 16 showing the temporal variation of moisture content during the open sun drying process in the month of December, 2011.

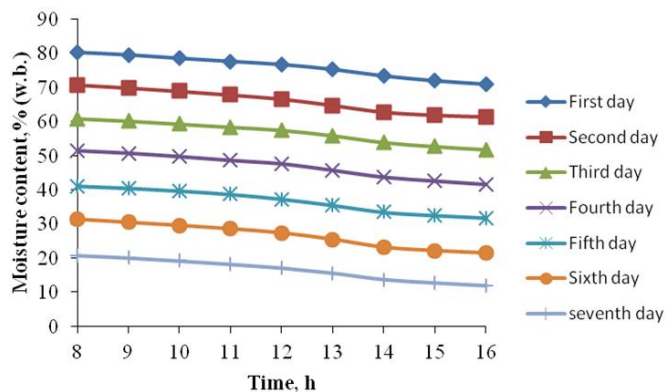

**Fig. 16.** Temporal variation of moisture content during the open sun drying process

### 4. Conclusion

The photovoltaic powered force convection solar dryer was designed and developed at workshop and tested at solar yard of Collage of Agricultural Engineering and Post Harvest Technology, Central Agriculture University, Ranipool, Gangtok, Sikkim for small farmer and households in NEH region. The dryer had capacity to dry 6 kg fresh chilli in 32 hours. The tests were conducted from 0.800 to 16.00 hrs and the hourly recorded. The full load testing of dryer was conducted for evaluating the performance in actual loaded condition. In order to compare the efficiency of drying in photovoltaic powered force convection solar dryer, open sun drying was also conducted. The chilli was dried within 32 hrs from initial moisture content 80.2% to final moisture content about 10% w.b. In order to compare the efficiency of drying in solar dryer PV powered forced convection, open sun drying was also conducted and it was observed that within 56 hrs chilli was dried from moisture content 80.2% to 11.9% w.b.

### References

- [1] Desai, S., Palled, V.K. and Anantachar, M. 2008. Performance evaluation of farm solar dryer for chilli drying. *Journal of Agriculture Sciences* 22(2): 382-384.
- [2] Fortson, F.K., Nazha, M. A. A., Akuffo, F.O. and Rajakaruna, H. 2006. Design of mixed mode natural convection solar crop dryer: Application of principles and rules of thumb. *Journal of Renewable energy* 32: 2306-2319
- [3] Folarami, J. 2008. Design, constructional and testing of simple solar maize dryer. *Leonardo Electronic Journal of Practices and Technology*: 122-130.
- [4] Gatea, A. A. 2010. Design, construction and performance evaluation of solar maize dryer. *Journal of Agriculture Biotechnology and Sustainable Development* 2(3): 39-49.
- [5] Gatea, A. A. 2011. Performance evaluation of mixed-mode solar dryer evaporating moisture in beans. *Journal of agriculture Biotechnology and Sustainable Development* 3(4): 65-71.
- [6] Mumba, J., 1996. The development of a photovoltaic powered forced convection solar maize dryer for use in Sub-Saharan Africa. *Journal of RERIC International Energy* 18(1): 27-42.
- [7] Mohanraj, M. and Chandrasekar, p. 2009. Performance of a forced convection solar dryer integrated with Gravel as heat storage material for chilli drying. *Journal of Engineering Science and Technology* 4(3): 305-314.
- [8] Okeke. C. A. and Nwokoye A. O. C. 2008. A comparative study of cabinet solar dryer and open sun drying of agriculture produce: (A Case of Unripe Plantain, Breadfruit and Bitter Leaf). *Journal of Natural and Applied Sciences* 9 (1): 1- 8.
- [9] Prasad, J., Vijay, V.K., Tiwari G.N. and sorayan V.P.S. 2004. Study on performance evaluation of hybrid drier for turmeric drying at village scale. *Journal of Food Engineering* 75(4): 496-502.
- [10] Sawhey, R. L., Pangavadia D.R. and Sarsavadia P. N. 2000. Design, development and performance testing of a new natural convection solar dryer. *Energy* 27: 579-590.
- [11] Yusuf, M. O. L. and Oghenervona, D. 2011. Design and fabrication of a direct natural convection solar dryer for Tapioca. *Leonardo Electronic Journal of Practices and Technology*: ISSN 1583-1078.