

# Study and Control of a Variable-Speed Wind-Energy System Connected to the Grid

Mohamed Mansour<sup>‡</sup>, M. N. Mansouri , M.F. Mmimouni

National Engineering School of Monastir , Electrical Engineering Department, 5019 Monastir – Tunisia

<sup>‡</sup> Mohamed MANSOUR; Address : National Engineering School of Monastir, 5019 Monastir – Tunisia, Tel: (+216) 73 500 511, Fax: (+216) 73 500 514, e-mail: med.mansour@yahoo.fr, mohamednejib.mansouri@enim.rnu.tn, Mfaouzi.mimouni@enim.rnu.tn

*Received:15.04.2011 Accepted:17.05.2011*

**Abstract-** Wind energy is a prominent area of application of variable-speed generators operating on the constant grid frequency. This paper describes the operation and control of one of these variable-speed wind generators : the direct driven permanent magnet synchronous generator (PMSG). This generator is connected to the grid by means of an IGBT rectifier, a DC bus, an IGBT inverter and a filter. The modelling of the converters is made by using the concept of instantaneous average value. We have used an aleatory profile of wind speed in order to illustrate the different controls realized, especially with maximum power point tracking algorithm (MPPT) and Pitch control at wind turbine level. To control the voltage of the continuous bus and the exchanges of active and reactive powers, we have used proportional integral correctors. The simulation results under Matlab\Simulink obtained and commented in order to validate the control strategy adopted.

**Keywords-** Variable-speed wind turbine, MPPT, Pitch control, PMSG, Control, Grid.

## 1. Introduction

Nowadays, the extraction of power from wind at a large scale became a well recognized industry. This fast development of the wind power industry was possible due to several reasons, like: the increasing resistance regarding the use of coal, oil or uranium, the high price of oil and the climate change problem. By the end of 2008, the world total installed capacity of wind turbines reached 122 GW and it is predicted that will exceed 300 GW by the year 2013 [1].

Because of the rapid development of power electronic devices and thus decreasing equipment costs, the variable speed wind turbine concept with full-scale frequency converter has an increasing market share. The most common generators used in this topology, the doubly fed induction generators (DFIGs) and permanent magnet synchronous generators (PMSGs), allow

the extraction of maximum power from a large wind speed interval. [2],

The PMSG with a high pole number for low speed, are also used in order to avoid having a mechanical gearbox. It has some valuable advantages over the DFIG such as : better efficiency, easier controllability, no need for reactive magnetizing current and they are smaller in size.

The PMSG wind turbine, in general, is connected to the power grid using a full-size, properly controlled frequency converter technology. Two types of converter topologies are available these days. One, in which, the frequency converter is composed of a diode-rectifier, DC-chopper, DC bus, and DC/AC inverter. In the other topology, the frequency converter is composed of an IGBT-rectifier, DC bus, and DC/AC inverter.

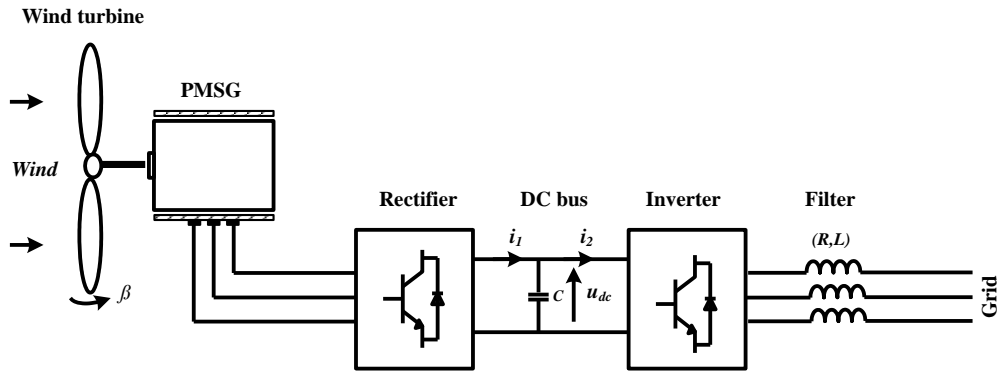

Fig. 1. Configuration of a PMSG wind turbine

In [3], the control of a variable-speed permanent-magnet generator with a diode-rectifier followed by a dc chopper is shown. With this configuration the control of the generator power factor is not possible, which in turn, affects generator efficiency. Also, high harmonic distortion currents are obtained in the generator that reduce efficiency and produce torque oscillations.

This paper describes the modelling and control system of a direct-drive variable-speed permanent-magnet generator with an IGBT-rectifier, connected to the grid. The presented topology is subjected to a number of control schemes : Pitch angle control for limiting the output power above rated values, MPPT (Maximum Power Point Tracking) control for extracting of the maximum power and grid side inverter control for active, reactive power flow control, and constant DC bus control.

The proposed global model can easily be simulated with the help a software like Matlab-SIMULINK. Simulations are carried out by considering a 750 kW wind generator.

The configuration of the studied generation system in this paper is represented in Fig 1

## 2. Wind turbine

### 2.1. Wind turbine modelling

The aerodynamic power at the rotor of the turbine is given by the following equation :

$$P_t = \frac{1}{2} \rho \pi R_t^2 v^3 C_p(\lambda, \beta) \quad (1)$$

where  $\rho$  ( $\text{kg.m}^{-3}$ ) is the air density,  $R_t$  (m) is the turbine radius,  $v$  ( $\text{m.s}^{-1}$ ) is the wind speed and  $C_p(\lambda, \beta)$  is the power coefficient which represents the aerodynamic efficiency of the turbine and also depends on speed ratio  $\lambda$  and the pitch angle  $\beta$ .

The speed ratio  $\lambda$ , is given by :

$$\lambda = \frac{R_t \Omega_t}{v} \quad (2)$$

$\Omega_t$  is the mechanical turbine speed (rad/s).

The mechanical torque produced by the turbine is expressed as follows [4] :

$$C_t = \frac{1}{2} \rho \pi R_e^3 v^2 C_m(\lambda, \beta) \quad (3)$$

$C_m(\lambda, \beta)$  is the torque coefficient :

$$C_m(\lambda, \beta) = \frac{C_p(\lambda, \beta)}{\lambda} \quad (4)$$

For different values of  $\beta$ , the  $C_p(\lambda, \beta)$  curves are shown in Fig.2.

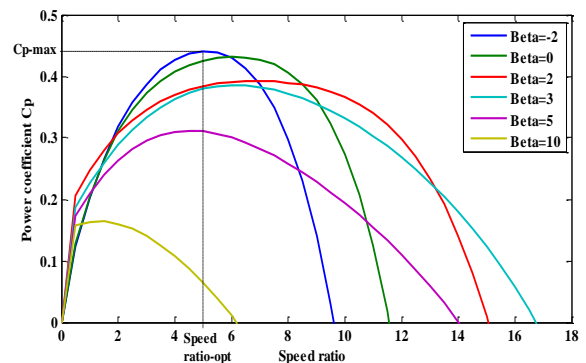

Fig. 2. Power coefficient characteristic versus speed ratio  $\lambda$  and pitch angle  $\beta$

We note the existence of the maximal value of power coefficient  $C_{pmax}$  corresponding to the optimal value of the speed ratio  $\lambda_{optimal}$  for each value of pitch angle  $\beta$ . The maximum value of  $C_p$ , that is  $C_{pmax}=0.44$ , is achieved for  $\beta=-2^\circ$  and for  $\lambda=5$ . This particular value  $\lambda_{opt}$  results in the point of optimal efficiency where the maximum power is captured from wind by the wind turbine.

### 2.2. Mechanical shaft modeling

The evolution of the mechanical speed of the synchronous generator can be easily determined using the dynamic equation. The simplified model of this equation is given by:

$$J_T \frac{d\Omega_t}{dt} = C_t - C_{em} - f \Omega_t - C_s \quad (5)$$

where  $J_T$  (kg.m<sup>2</sup>) is the total inertia which appears on the shaft of the generator,  $\Omega_t$ (rad/s) is the turbine speed,  $C_t$ (N.m) is the mechanical torque,  $C_{em}$  (N.m) is the electromagnetic torque,  $C_s$  (N.m) is the dry friction torque and  $f$  (N.m.s.rad<sup>-1</sup>) is a viscous friction coefficient.

### 2.3. Pitch angle control

The pitch control is an essential method for controlling the rotational speed of wind turbine. It activates when the rotor speed exceeds the maximum rotor speed of turbine  $\Omega_m$ , by giving the order to increase the pitch angle to reduce the turbine torque  $C_t$ . The Fig 3 shows the speed limit.

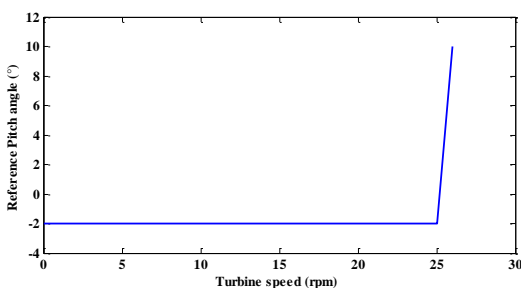

Fig. 3. Reference Pitch angle

For variable-speed wind turbines, a mechanical actuator is usually employed to change the pitch angle of the blades in order to reduce power coefficient  $C_p$  and maintain the power at its rated value. This speed actuator is an actuator

proportional presenting a not – linearity. The torque has been supposed proportional to rotational speed of the turbine by linearization of the model to order 1 [4-6]. The control strategy implemented is as follows :

$$\begin{cases} \beta_{ref} = \beta_0 = -2 & \text{for } 0 < \Omega_t \leq \Omega_{tn} \\ \beta_{ref} = \frac{\Delta\beta}{\Delta\Omega} (\Omega_t - \Omega_{tn}) + \beta_0 & \text{for } \Omega_t > \Omega_{tn} \end{cases} \quad (6)$$

with  $\beta_0$  (°) is the initial pitch angle (optimal value) and  $\Omega_{tn}$  (rad/s) is the Nominal mechanical turbine speed.

After, to take into account the orientation system of the blades which can be of type hydraulic or electric, we introduce a transfer function of the first order. The purpose of this system is to control the position of the blades according to a reference.

$$\beta = \frac{1}{1 + \tau_b s} \beta_{ref} \quad (7)$$

$s$  is the Laplace operator and  $\tau_b$  is the time-constant of the orientation system of the blades.

Fig.4 shows the block diagram of the Pitch angle control system implanted in the simulation software Matlab-Simulink.

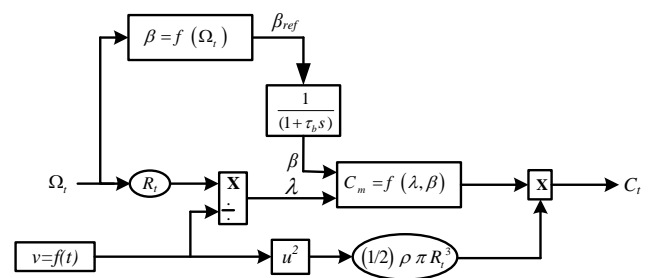

Fig. 4. Scheme of the implemented pitch control method

## 3. Permanent-Magnetic Synchronous Generator (PMSG)

### 3.1. Modelling

The model generally used of the PMSG is the Park model. By considering only the fundamental harmonic of the flux distribution in the air-gap of the machine and by neglecting the homopolar component, the theory of the space vector gives

the dynamic equations of the stator currents as follows :

$$\begin{cases} \frac{di_{sd}}{dt} = \frac{1}{L_s} (v_{sd} - R_s i_{sd} + L_s p \Omega_r i_{sq}) \\ \frac{di_{sq}}{dt} = \frac{1}{L_s} (v_{sq} - R_s i_{sq} - L_s p \Omega_r i_{sd} - p \Omega_r \phi_a) \end{cases} \quad (8)$$

where  $R_s$  is the phase resistance of the stator winding ( $\Omega$ ),  $L_s$  is the stator cyclic inductance (H),  $\Phi_a$  is the flux of the permanent magnetic (Wb),  $v_{sd}$  and  $v_{sq}$  are the d-q components of the stator voltages respectively (V),  $i_{sd}$  and  $i_{sq}$  are the d-q components of the stator currents respectively (A), and  $p$  is the number of pairs of poles.

The electromagnetic torque is given by :

$$C_{em} = p \phi_a i_{sq} \quad (9)$$

### 3.2. Control

In a variable-speed wind turbine, maximum power is a cubic function of rotational speed. To maximize efficiency, losses for a given load must be minimized. A stator q-axis current component is used to develop generator torque, but a freedom degree remains to set direct current. A direct-axis current component can be set at zero to minimize current for a given torque, and therefore, minimize resistive losses [7]. Thus, the generator torque may be controlled directly by the quadrature current component.

Fig 5 shows the schematic diagram of the control loops of the permanent-magnet generator-side converter. The required  $d$ - $q$  components of the rectifier voltage vector are derived from two proportional plus integral (PI) current controllers: one of them controlling the d-axis component of the current and the other one the q-axis component. Compensation terms are added to improve the dynamic response. The control requires the measurement of the stator currents, dc voltage, and rotor position. Pulse Width Modulation (PWM) is used to generate the switching signals for the power converter semiconductors.

## 4. Control of the wind generator

To control the generator power, it is enough to control the PMSG electromagnetic torque  $C_{em}$ , by regulation of the stator current and to know the rotational speed of the shaft. The pitch control system intervenes to limit this rotational speed. The reference electromagnetic torque  $C_{em-ref}$ , can be developed in two different methods [8] :

The first method for an operating at maximum power, aims at improving the aerodynamic output of the turbine in order to extract the wind power maximum. This power is extracted when the turbine operates at maximum power coefficient.

Equation 10 gives the expression of the maximum power obtained using the strategy MPPT (Maximum Power Point Tracking), which permit to adjust automatically the ratio speed at its optimum value  $\lambda_{opt}$ , in order to obtain the maximum power coefficient  $C_{pmax}$  (Fig. 2). This equation shows the relationship between turbine power and turbine speed at maximum power. When regulating the system under the specification of maximum power, it must be taken into account that turbine power must never be higher than generator rated power. Once generator rated power is reached at rated wind speed, output power must be limited.

$$P_{MPPT} = \frac{\rho \pi R_e^5 C_{pmax}}{2 \lambda_{opt}^3} \Omega_t^3 = K \Omega_t^3 \quad (10)$$

$$C_{em-ref} = \frac{P_{MPPT}}{\Omega_t} = K \Omega_t^2 \quad (11)$$

The second method for a nominal operating of the wind generator, is used to maintain the generator power at its rated value in the case of high winds. This operating mode is obtained with the pitch angle control.

The control structure of the wind generator is given in Fig. 5.

## 5. Modeling of Power Converters

The power converter consists of two back-to-back insulated gate bipolar transistors (IGBTs) bridges; the one connected to the generator works



Thus, the active and reactive powers can be expressed as :

$$\begin{cases} P_r = v_{rd} i_{rd} \\ Q_r = -v_{rd} i_{rq} \end{cases} \quad (17)$$

Active and reactive power control can be achieved by controlling direct and quadrature current components, respectively. The control of this converter (inverter) is quite similar to that of the generator. Two control loops are used to control the active and reactive power, respectively [14].

An outer dc voltage control loop is used to set the d-axis current reference for active power control. This assures that all the power coming from the rectifier is instantaneously transferred to the grid by the inverter.

The second channel controls the reactive power by setting a q-axis current reference to a current control loop similar to the previous one. We impose zero reactive power as reference ( $Q_{r-ref} = 0$ ) in the system control, to ensure unitary power factor operation. The current controllers will provide a voltage reference for the inverter that is compensated by adding compensation terms. All controllers are PI.

### 7. DC bus modeling and control

From Fig 1, the evolution of the DC voltage can be deduced :

$$\frac{du_{dc}}{dt} = \frac{1}{C} (i_1 - i_2) \quad (18)$$

Classically, the active power reference value is determined by the continuous voltage controller. This power reference depends in fact on the active power consumed or generated by the wind generator which can be estimated from (13) as follows :

$$P_{w-ref} = u_{dc-ref} i_1 \quad (19)$$

$u_{dc-ref}$  is the DC voltage reference value. Fig 6 shows the continuous voltage control and the active power reference value determination

taking into account (19). The DC voltage control compensates the converter losses which are neglected in (19).

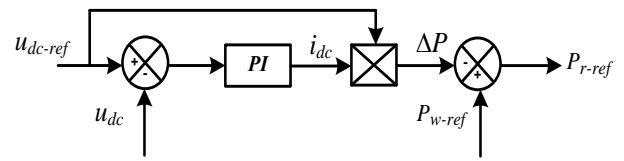

Fig. 6. DC voltage control and active power reference value generation

The control scheme of inverter is presented in Fig. 7.

### 8. Simulation process and results

In this section, to show the principle of power control of PMSG-based variable-speed wind turbine connected to the grid, it is controlled in order to capture the maximum wind energy and its behavior subjected to a variable speed wind will be illustrated using numerical simulations carried under the Matlab - SIMULINK. The wind speed varies according to the profile in Fig 8.

We will show the PMSG speed  $N_t$  (rpm), the pitch angles  $\beta_{ref}$  and  $\beta$ , the power coefficient  $C_p$ , the electromagnetic torques  $C_{em-ref}$  and  $C_{em}$ , the wind power  $P_w$ , the DC bus voltage  $u_{dc}$ , the active powers  $P_r$  and  $P_{r-ref}$ , the reactive powers  $Q_r$  and  $Q_{r-ref}$ , and the grid currents  $i_{rabc}$

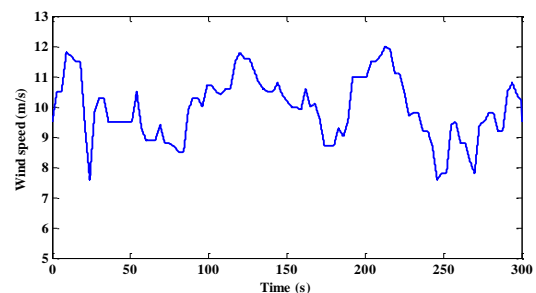

Fig. 8. Wind speed profile

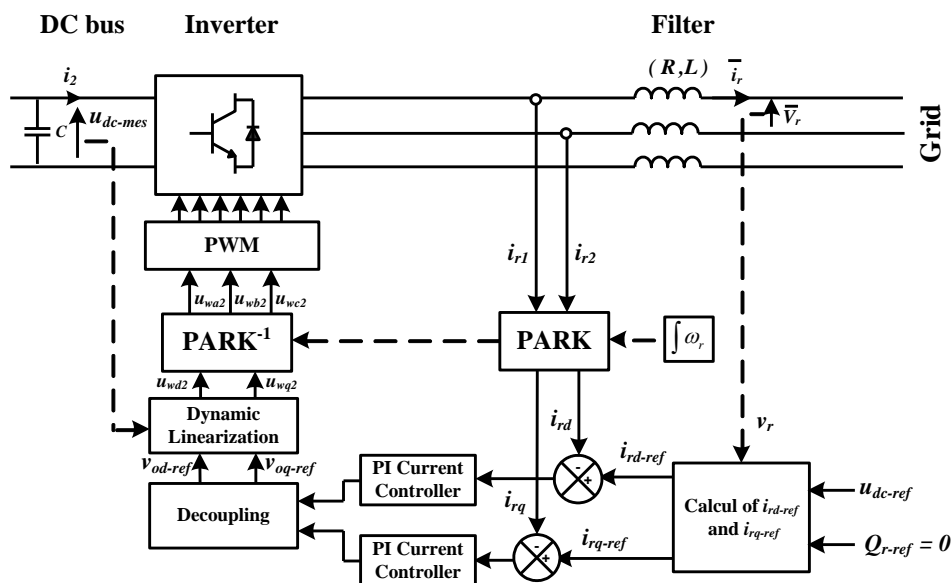

Fig. 7. Control scheme of inverter

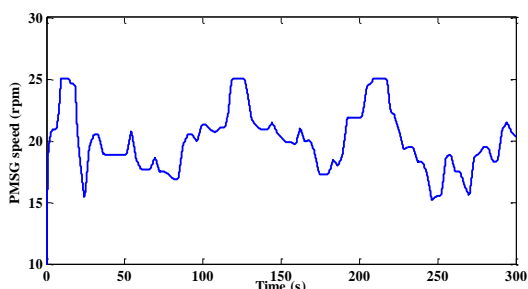

Fig. 9. PMSG speed  $N_t$

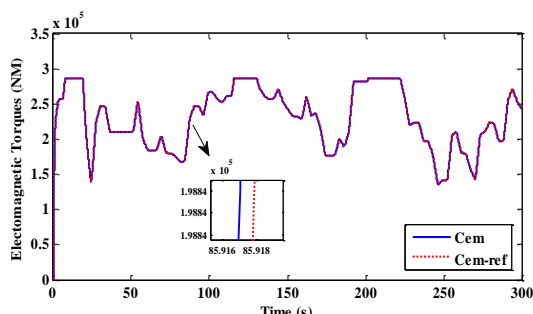

Fig. 12. Electromagnetic torques  $C_{em-ref}$  and  $C_{em}$

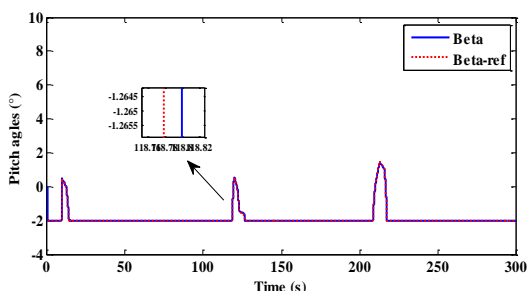

Fig. 10. Pitch angles  $\beta_{ref}$  and  $\beta$

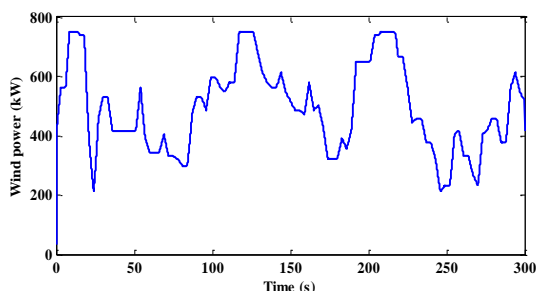

Fig. 13. Wind power  $P_w$

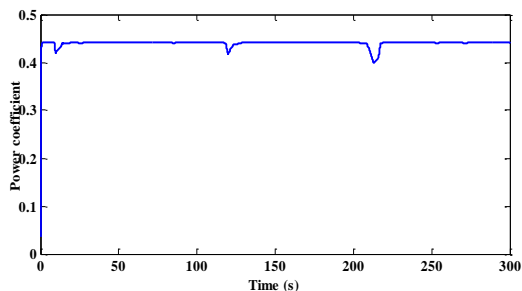

Fig. 11. Power coefficient  $C_p$

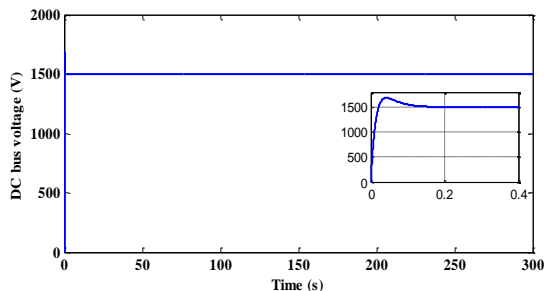

Fig. 14. DC bus voltage  $u_{dc}$

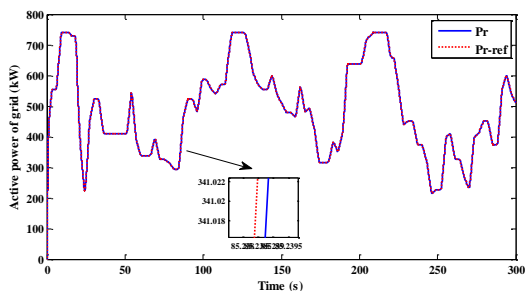

Fig. 15. Active powers  $P_r$  and  $P_{r-ref}$

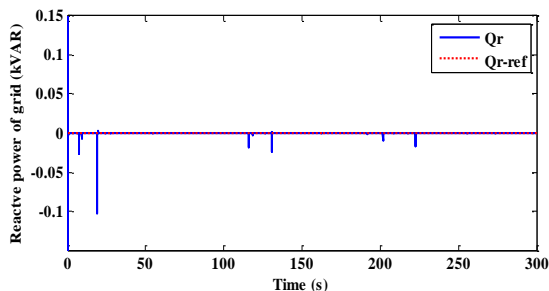

Fig. 16. Reactive powers  $Q_r$  and  $Q_{r-ref}$

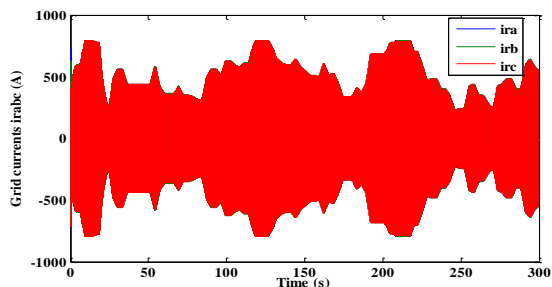

Fig. 17. Grid currents  $i_{rabc}$

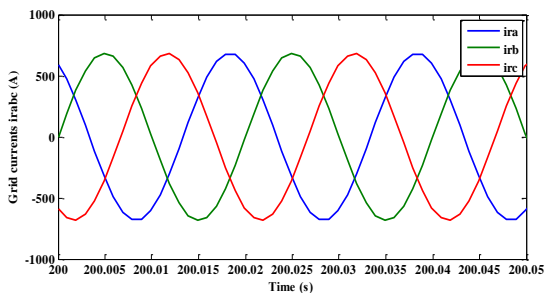

Fig. 18. Zoom on grid currents  $i_{rabc}$

The wind generator is controlled in order to capture the maximum wind energy. When rotational speed is low than the nominal value (25 rpm) (Fig 9), the conversion system operate under MPPT control. But when the wind speed exceeds the nominal value, the Pitch angle increases to reduce the turbine torque (Fig 10) and the power coefficient decreases (Fig 11)

with keeping constants rotational speed and power generated.

Fig 10 shows also that the Pitch angle follows well its reference. Consequently, we prove the efficiency of the implanted actuator.

It is easy to check that the PMSG speed (Fig 9), the electromagnetic torque (Fig 12) and the wind power (Fig 13) are deeply correlated with the wind speed.

The wind power is optimized with MPPT strategy and keeps at his nominal value when the turbine speed exceeds the nominal value (Fig 13).

The DC bus voltage is represented in Fig 14 which demonstrates that this voltage is perfectly constant equal to 1500 V and thus proves the effectiveness of the established regulators.

The Fig 15 shows the active power of grid which is substantially equal, except for the losses, to the generated power by wind source.

The reactive power reference value is maintained equal to zero (Fig 16). Then, we operate with unitary power factor.

The injected currents to the grid are represented in Fig 17 and 18. It is easy to prove that they are three sinusoidal currents with constant frequency equal to 50 Hz, and variable amplitude according to the wind speed variation.

## 9. Conclusion

The main focus of this paper has been the study and control of a direct-driven PMSG used in variable speed wind-energy system connected to the grid. This wind system was modelled using d-q rotor reference frame and is interfaced with the power system through an inverter and a filter modeled in the power system reference frame. The control strategy developed insured power optimization with conventional MPPT strategy and limitation over the rated turbine speed by Pitch angle control. The inverter control allowed, through grid current regulation, to achieve a decoupled active and reactive power control for operate with unitary power factor.

The proposed global model was simulated with the help a software like Matlab-Simulink.



The simulation results showed the effectiveness of the control strategy adopted.

## Appendix

### Wind turbine

Radius:  $R_e = 24$  m

Number of blades : 3

Nominal rotational speed :  $N_m = 25$  rpm

$\lambda_{optimal} = 5$

$C_{pmax} = 0.44$

Density of air :  $\rho = 1.22$  kg.m<sup>-3</sup>

Dry friction torque :  $C_s = 953$  Nm

Viscous friction coefficient :  $f = 0$  N.m.s.rad<sup>-1</sup>

Total inertia of the mechanical transmission :

$J_T = 10^5$  kg.m<sup>2</sup>

### PMSG

Nominal power :  $P_n = 750$  kW

Nominal speed of the turbine :  $N_m = 25$  rpm

Stator resistance :  $R_s = 0.01\Omega$

Self-inductance :  $L_s = 7.79$  mH

Permanent magnetic flux :  $\Phi_a = 7.3509$  Nm/A

Number of pole pairs :  $p = 42$

### DC bus and filter

DC bus voltage :  $u_{dc} = 1500$  V

Equivalent capacitance:  $C = 10$  mF

Filter resistance :  $R = 0.01\Omega$

Filter inductance :  $L = 1$  mH

## References

- [1] BTM Consult, Ringkobing, Denmark, *World Market Update 2008, Forecast 2009-2013*, 2009.
- [2] Cristian Busca, Ana-Irina Stan, Tiberiu Stanciu and Daniel Ioan Stroe, "Control of Permanent Magnet Synchronous Generator for Large Wind Turbines" IEEE International Symposium on Industrial Electronics, (ISIE 2010) July 04-07, 2010, Bari, Italy.
- [3] Z. Chen and E. Spooner, "Simulation of a direct drive variable speed energy converter," in *Proc. Int. Conf. Electrical Machines*, Istanbul, Turkey, 1998, pp. 2045-2050.
- [4] Leclercq Ludovic, « Apport du stockage inertiel associé à des éoliennes dans un réseau électrique en vue d'assurer des services systèmes ». Thèse de Doctorat : Génie Electrique : Université des Sciences et Technologies de Lille, Villeneuve d'Asq, 2004, 171 p, n°3563.
- [5] R. Chedid, F. Mirad et M. Basma, « Intelligent control of a class of wind energy conversion systems », IEEE Transactions on Energy Conversion, Vol. 14, 1999, n°4.
- [6] J. L. Rodriguez – Amenedo, S. Arnalte et J. C. Burgos, « Automatic generation control of wind farm with variable speed wind turbine », IEEE Transactions on Energy Conversion, Vol. 17, 2002, n°2
- [7] W. Leonhard, Control of Electrical Drives. New York: Springer, 1997.
- [8] V. Courtecuisse , «Supervision d'une centrale multisources à base d'éoliennes et de stockage d'énergie connectée au réseau électrique. », Th : Génie Electrique : Ecole Nationale Supérieure des Arts et Métiers,Lille, 2008.
- [9] B. François, J.P. Hautier, "Comande d'un onduleur triphasé de tension par modulateur de largeur et de position d'impulsions", Revue Internationale de Génie Electrique, p. 359-387, Vol. 2 N° 3, Octobre 1999.
- [10] B. Robyns, Y. Pankow, L. Leclercq, B. François, "Equivalent continuous dynamic model of renewable energy systems", 7th International Conference on Modelling and Simulation of Electric machines, Converters and Systems: Electrimacs 2002, CD, 18-21 Aout 2002, Montreal, Canada.
- [11] B. Robyns, M. Esselin, "Power control of an inverter-transformer association in a wind generator", Electromotion, vol 6, n°1-2, 1999, pp3-7.
- [12] M. Esselin, B. Robyns, F. Berthereau, J.P Hautier, "Resonant controller based power control of an inverter transformer association in a wind generator", Electromotion, vol 7, n°4, 2000, pp 185-190.
- [13] M. Chinchilla, S. Arnaltes and J. C Burgos, «Control of Permanent-Magnet Generators Applied to Variable-Speed Wind-Energy Systems Connected to the Grid », IEEE Transactions on Eenergy Conversion, Vol 21, N°1, March 2006.
- [14] R. Pena, J. C. Clare, and G. M. Asher, "Doubly fed induction generator using back-to-back PWM converters and its application to variable-speed wind-energy generation," *Proc. Inst. Elect. Eng.—Elect. Power Appl.*, vol. 143, no. 3, pp. 231-241, May 1996.