

Solar Assisted Heat Pump System for High Quality Drying Applications: A Critical Review

J. Assadeg^{1,2}, Ali H. A. Alwaeli¹, K. Sopian^{1‡}, H. Moria³, A. S. A. Hamid^{1,4} and A. Fudholi¹

¹Solar Energy Research Institute, Universiti Kebangsaan Malaysia, 43600, Bangi, Selangor, Malaysia

²Renewable Energy Engineering Department Collage of Energy and Mining Engineering, Sebha University, Libya

³Department of Mechanical Engineering Technology, Yanbu Industrial College, Yanbu Al-Sinaiyah 41912, Kingdom of Saudi Arabia

⁴Faculty of Science and Natural Resources, Universiti Malaysia Sabah, 88400 Kota Kinabalu, Sabah, Malaysia

(jassadeg@gmail.com, ali9alwaeli@gmail.com, ksopian@ukm.edu.my, hazimmoria@gmail.com, pian@ums.edu.my, a.fudholi@ukm.edu.my)

‡ Corresponding Author; K. Sopian, Solar Energy Research Institute, Universiti Kebangsaan Malaysia, 43600, Bangi, Selangor, Malaysia, Tel: +03 89118572, Fax: + 03 89118574, ksopian@ukm.edu.my

Received: 15.01.2020 Accepted: 28.02.2020

Abstract- Solar assisted heat pump (SAHP) system integrates a solar thermal energy source with a heat pump. This technique is a very fundamental concept, especially for drying applications. By combining a solar thermal energy source such as solar thermal collectors and a heat pump dryer will assist in reducing the operation cost of drying and producing products with high quality. Many review papers in the literature evaluated the R&D aspects of solar-assisted heat pump dryers (SAHPD). This critical review paper studies some of the researches conducted in this field to understand and provides an update on recent developments in SAHPD. Also, a detailed explanation of principles and operation for SAHPD and its applications are presented. The used types of solar thermal collectors, as well as various heat pump dryers, are all discussed in this article. Finally, it is concluded that there is a clear lack of research in the techno-economic and environmental evaluation, while most of SAHPD studies focused on the performance study of the system.

Keywords heat pump, collector, two phases, refrigerant, compression index.

Nomenclature

η_v	Volumetric efficiency	\dot{m}	Mass flow rate
\dot{m}_r	Mass refrigerant flow	T_s	Wetted surface temperature
P	Pressure	U_{wi}	Combined coefficient of heat transfer for tube wall, refrigerant and water film
V	Velocity		
k	Compression index	ω	absolute humidity ratio
c	Clearance volume of compressor ratio	PD	Piston displacement
C_{min}	Smaller heat capacity rate		
C_c	Heat capacity rate of cold fluid	Subscripts	
ε	Heat exchanger effectiveness	a	Air
ε_{tp}	Heat exchanger effectiveness of two phases	tp	Two phases
$T_{a,o}$	Outlet temperature of air	i	Inlet or Inside
$T_{a,i}$	Intel temperature of air	o	Outlet or Outside
$T_{r,i}$	Intel temperature of working refrigerant	s	Saturated condition
T_d	Temperature of water film	r	Working refrigerant
U_a	Heat transfer coefficient of the air	h	Hot fluid
A	Heat transfer area	c	Cold fluid
Q	Heat transfer rate	w	properties evaluated at wall temperature or water film
h	Heat transfer coefficient	v	Saturated vapor

1. Introduction

The global increase of demand for energy and the corresponding increase in the rate of depletion of fossil fuels are complex modern issues that require joint efforts in terms of energy management and technology innovation to present practical approaches to dealing with energy issues. Non-fossil fuel energies such as solar, wind, and biofuel energy are encouraged as alternative energy sources due to their abundance and environmental friendliness [1]. The current use of fossil fuels, although necessary, often leads to the emissions of toxic and harmful gases to the environment. The alternative, renewables is undoubtedly less harmful, especially in the case of solar where emission is about zero. In this respect, two leading solar technologies have been identified: solar photovoltaic (PV) and solar thermal collectors [2].

The former produces electrical energy, while the latter is used for heating purposes and hence thermal energy. The main advantages of solar are their abundance, free-cost, and zero-emissions [3]. Solar technologies can be useful for residential, commercial and industrial purposes in different scales of production. Many applications that stem from solar energy systems are solar water pumping systems, residential solar water heaters, pre-heating for industrial purposes, and solar assisted heat pumps. Heat pumps are devices used to transfer heat energy from sources of heat to heat sinks. Hence, heat pumps absorb heat from cold environments and release it into warmer ones [4]. Typical heat pumps consist of a condenser, an expansion valve, an evaporator, and a compressor, as four main components; working in a cycle. The heat transfer medium of the HP is referred to as refrigerant [5]. Heat pump systems present an efficient alternative to recover heat from various sources for use in different applications at residential, commercial, and industrial setup. The value of heat pumps is highlighted by the need to reduce the cost of energy and improve overall energy efficiency. Therefore, these technologies are critical for the energy recovery system and have massive potential for energy saving. Solar Assisted Heat Pumps (SAHP) is a novel hybrid system that utilizes solar energy as a heat source for the heat pump. By this hybrid system, HP's performance is significantly enhanced and energy

costs substantially reduced [6]. This system has the potential for improved performance of heat pump, better environmental impact, and lower costs. Chaturvedi et al. [7] proposed a direct expansion solar assisted heat pump (DX-SAHP) for applications on domestic hot water. The system simultaneously collects solar energy and evaporates the refrigerant in one element, as appose to conventional SAHP, where this process only occurs over two elements. The novelty of their study was in the application of a variable frequency drive (VFD) to modulate the compressor speed in order to match heat pump capacity of compressor and evaporative capacity of the collector under different ambient conditions. So, their study examines changes in thermal performance of heat pump due to changes in compressor capacity. The authors claim that when ambient temperature increases, from winter to summer, the lowering of compressor speed leads to significant improvement in coefficient of performance of the system. The results of their experiments also reveal that at higher ambient temperature, summer season, the heat rate achieved from the system is higher, as opposed to conditions of the winter season. Cervantes et al. [8] have investigated the experimental exergy efficiency of a SAHP with direct expansion of refrigerant within the solar collector. The exergy flow in each component in the HP cycle was determined with consideration for performance coefficients and typical parameters. The experiments were conducted with solar irradiance ranging between 200 W/m^2 and 1100 W/m^2 , ambient temperature ranging between $20 \text{ }^\circ\text{C}$ and $32 \text{ }^\circ\text{C}$. While, the electricity consumption of compressor was around 1.1 kW to 1.36 kW . Their exergy findings show that the solar collector of the HP and evaporator are the key sources of irreversibility. The thermodynamic analysis presented in their study is useful for implementation in various systems and settings.

The applications of SAHP include water heating [9,10], heat storage [11], and drying [12]. Drying of agricultural products, which is also known as SAHPD, is another application of SAHP systems. Hawlader et al. [13] designed, fabricated and tested a SAHPD for performance evaluation of air and evaporator collectors in Singapore within the same meteorological conditions. The

experimental set-up was made of air-path and refrigerant-path. The study investigates the performance of SAHPD when coupling the air collector (single-phase collector) with a collector evaporator (two-phase flow collector) in an integrated system. R134a type refrigerant was used in the heat pump. The authors claim that the coupling of the solar collector and heat pump have been found to have improved the thermal efficiency of air collectors between 70 % to 75 %, while the efficiency of evaporator-collector was found between 80 % and 86 % which is attributed to the reduction of the collectors' losses. Hence, a two-phase flow collector exhibits impressive performance compared to a single-phase flow collector in the SAHPD system. Moreover, the high efficiency of the air collector was mainly affected by the dehumidifier without which the efficiency will range between 42 % and 48 %. Best et al. [14] examined the SAHPD's performance for rice drying. The system employs a modified 7-kW-R-22 air conditioner unit combined with a solar collector to precisely manage humidity and temperature. The solar collector is single glazed and located at the end of the drying chamber. Authors also found that the system exhibits high energy-saving and low specific energy consumptions. Ibrahim et al. [15] evaluated the performance of a solar-assisted chemical HP dryer, which uses the evacuated tube type solar collector, a chemical HP unit, a drying chamber, and a storage tank. The study employs a simulation for the system with Malaysia's meteorological data. The monthly evacuated tube solar collector's efficiency was found to be ranging between 59 – 64 %. The authors discovered a maximum coefficient of performance for heating (COP_h) of 1.8. The highest coefficient of performance is predicted in March, while the lowest in November. The solar fraction of the system was found at around 0.4 for a collector area of 10 m². The decrease in coefficient of performance and drying efficiency was attributed to the decline in solar irradiance, which leads to a reduction of energy at the condenser. Studies throughout the literature show the utility of SAHPD for drying purposes. While other means of drying products through the utilization of solar energy exists, as shown by Troeger and Butler [16] who dried peanuts using model bins amounting to 12 bins. Eight of the bins used air heated with Liquefied Petroleum Gas

(LPG) while the remaining four used air which was heat from solar-heated water through an air-water crossflow heat exchanger. Two airflow rates were used for the dryers and different initial moistures were dried through the method of periodically interrupting airflow. Short interruptions, as in 15 min/h, for low airflow rates, had the minimal effect of drying time but reduced consumption of heat-energy by 10 %. While more prolonged interruptions lead to more drying time, it does reduce the heat energy. At high airflow rates, the moisture was found to be more similar. And they conclude that heat energy savings of both LPG and solar-heated dryers were comparable.

The nature of the direct application affects the design of SAHPD, such as having a heat storage unit or not. The system typically contains various refrigeration components, as well as the solar element. Inlet drying air picks up moisture from the target after passing through the drying chamber. The HP acts like a dehumidifier by allowing humid air to pass over the evaporator from the dryer. The humid air temperature is first reduced reasonably during the process of dehumidification to a dew point to avoid water condensation from the air. Then, the evaporator absorbs sensible and latent heats to boil the refrigerant. The condenser is further used to boil the recovered heat. The quality of drying is highly critical for fruits and other food products. Hence, this paper aims to provide a review of advances in solar-assisted heat pump systems for drying applications. The study gives a general description of the system, classifications of SAHPD categories and detailed-description of main elements of air source heat pump drying systems, chemical heat pump drying system, and ground heat pump drying systems. In addition to introducing the solar thermal collectors. The working principle of SAHPD is explained in detail and overview selected agricultural products are provided from the literature. Finally, conclusions and recommendations are made for future research and development.

2. Classification of SAHPD

Figure 1 displays a comprehensive SAHPD classification for industrial, agricultural and marine products. SAHPD is classified into two main categories. (A) solar energy source and (B) heat

pump (HP) dryers. The solar energy source in SAHPD could be solar thermal collector, solar chimney system, solar photovoltaic collector

[17,18] or PV/thermal collector [19 – 24] coupled with an HP. The HP could be air source, chemical, ground source [25] or hybrid.

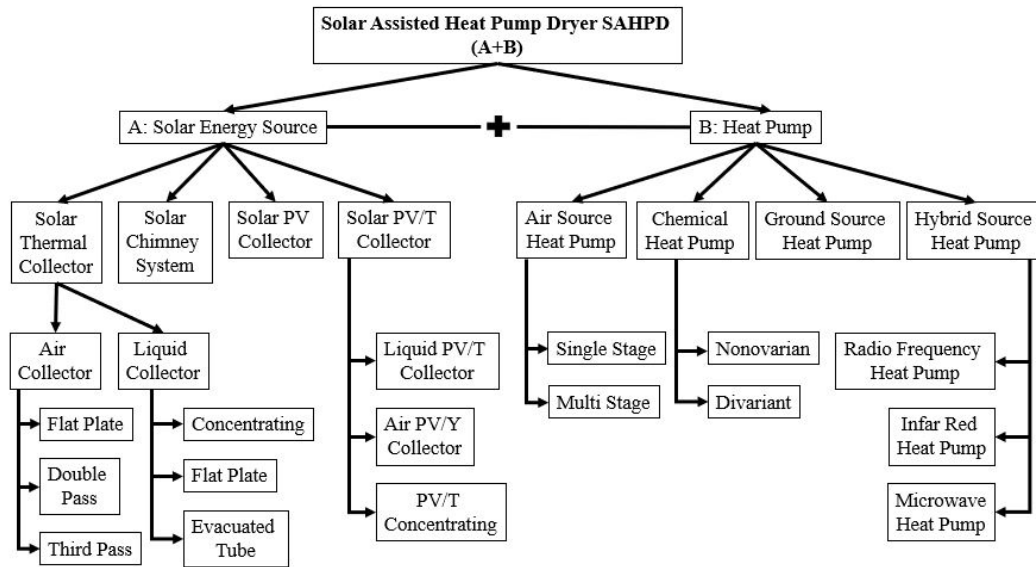

Figure 1. Classification of SAHPD

3. Solar Assisted Heat Pump Dryer (SAHPD)

In places with very rich sources of solar energy, the incorporation of a solar heating system to the (HPD) may further improve on the efficiency of the overall drying system. Such a system may also be appropriate for higher drying temperature. Easy conversion of natural energy for storage resulting in significant saving of energy, environmentally friendly process, easy to implement control strategy and higher operating temperature are the principal advantages of solar assisted heat pump dryer which will overcome the above mentioned problem in different technique of drying application. However, this would require some kind of backup auxiliary source or a thermal energy storage device when it comes to nightfall or cloudy days [6,12].

3.1. Heat pump

Heat pump would be an attractive option to overcome the difficulties of the solar drying system. For drying, heat pumps possess two beneficial characteristics. Through the evaporator, the heat pump recuperates sensible and latent heat from the dryer exhaust air hence, the energy is recovered. Condensation occurring at the

dehumidifier reduces the humidity of the working air [12].

3.1.1. Air source heat pump drying systems

Many researchers have acknowledged the specific features of heat pumps, which has resulted in the rapid growth of both theoretical and applied research on air source heat pump drying. Normally, the Air source heat pump consist of evaporator, condenser compressor and expansion valve [12].

3.1.1.1. Evaporator

The evaporator is considered as a heat exchanger and designed the same way as condenser but works in opposite by converting the refrigerant from liquid to gas. The air coming from the drying chamber is cooled and this led to extracting of its moisture by the evaporator in the air cycle.

$$T_{a,o} = T_{a,i} + \epsilon_{tp}(T_{a,i} - T_{r,i}) \quad (1)$$

$$\epsilon_{tp} = 1 - \exp(-NTU_{tp}) \quad (2)$$

The wet and dry regions are differentiated by the temperature which has been condensed of the air-water vapour mixture as given by [26]:

$$T_{o,d} = T_d + \frac{(T_d - T_r)U_{wi}A_i}{U_a A_o} \quad (3)$$

For these equations, that is heat transfer, the overall heat emanating from the air consists of latent and sensible parts:

$$Q_A = h_a(T_a - T_s)\Delta A_o + m_a h_{fg}\Delta\omega \quad (4)$$

Heat transfer to the working fluid as follows:

$$Q_r = U_{wi}(T_s - T_r)\Delta A_i \quad (5)$$

3.1.1.2. Condenser

The condenser is a device to condense the working fluid and reject its heat to the drying chamber. The NTU (Number of Transfer Units) technique is used to examine heat transfers in the condenser. The heat exchange effectiveness is given by [27]:

$$\varepsilon = \frac{C_c(T_{c,o} - T_{c,i})}{C_{min}(T_{h,i} - T_{h,i})} \quad (6)$$

or by given this formula:

$$\varepsilon = \frac{C_h(T_{h,i} - T_{h,o})}{C_{min}(T_{h,i} - T_{c,i})} \quad (7)$$

In two-phase regions of condenser, the refrigerant temperature remains stable at a point of saturation. The temperature of the existing air in the two-phase regions is provided by

$$T_{a,o} = T_{a,i} + \varepsilon_{tp}(T_{r,i} - T_{a,i}) \quad (8)$$

3.1.1.3. Compressor

A compressor is a mechanical unit that increases the pressure of working fluid from low to high pressure, which is usually associated with high temperature. [26] reported a scientific model of a compressor: the mass refrigerant flow and volumetric efficiency are as follow:

$$\eta_v = \left[1 + c - c \left(\frac{P_2}{P_1} \right)^{1/k} \right] \frac{V_2}{V_1} \quad (9)$$

$$\dot{m}_r = \frac{(PD)N\eta_v}{V_2} \quad (10)$$

The total work needed to run the compressor and discharge temperature are provided below:

$$W_c = P_1 V_1 \dot{m}_r \left(\frac{k}{k-1} \right) \left[\left(\frac{P_2}{P_1} \right)^{(k-1)/k} - 1 \right] \quad (11)$$

$$T_2 = T_1 \left(\frac{P_2}{P_1} \right)^{(k-1)/k} \quad (12)$$

3.1.1.4. Expansion Valve

A process where refrigerant pressure is controlled from high to low and allowed to expand or changes its state from liquid to vapour in the evaporator is known as the thermal expansion valve. The high-pressure refrigerant entering the thermal expansion valve is warm and leaving the expansion valve is cold as a result of refrigerant pressure. The expansion capacity should be of a considerable size so that the mass flow rate of refrigerant going through its capillary tube as well as through the compressor of the cycle.

3.1.1.5. Refrigerant

Refrigerant is the working fluid in the mechanical vapour compression cycle. Hydrochlorofluorocarbons (HCFCs), hydrofluorocarbons (HFC) as well as chlorofluorocarbons (CFCs) have been extensively used in refrigeration in the past few decades. CFCs were completely forbidden since 2006 in developed and developing countries due to the Montreal Protocol for the United Nations Environmental Program in 1987. Recently, ASHRAE classified the refrigerants based on the level of hazards involved in their use. The flammability and toxicity classification result in six safety refrigerant groups (B3, B2, B1, A3, A2, and A1). Group A1 is safer, while group B3 is most hazardous.

Table 1. Selected alternative refrigerants

Refrigerant	Chemical Nomenclature	Molecular Weight	Critical Temperature (°C)	Critical Pressure (bar)	Safety
R410A [28]	R32/125	72.6	70.2	47.5	A1
R450A [29-31]	R134a / R1234ze	108.6	105.6	38.4	A1
R448 [32]	R32/R125/R134a	86.3	83.6	45.	A1
R507 [33,34]	R-125/143a	98.9	76.1	37.9	A1
R717 [35,36]	NH ₃	17.03	132.4	111.5	B2
R290 [37-39]	CH ₃ CH ₂ CH ₃	44.10	96.8	42.4	A3

3.1.2. Chemical Heat Pump Drying Systems

Chemical heat pumps (CHPs) are thermal energy management systems that have several uses permitting a number of simultaneous functions and requiring no mechanical energy input. These uses include thermal energy storage, heat pumping, improving heat quality and refrigeration. Among industrial processes, certain unit operation such as drying, distillation, evaporation and condensation deal with large amount of enthalpy changes where CHP can be effectively utilized.

3.1.3. Ground Source Heat Pump Drying

Ground-source heat pump (GSHP) transforms the earth energy into useful energy to heat and cool. It provides low temperature heat by extracting it from the ground or a body of water. It can actually produce more energy than it uses, as it draws additional free energy from the ground. There are various studies on the ground source heat pump (GSHP) systems, whereas, few studies have been conducted regarding utilization of this kind of heat pumps for drying applications.

3.2. Solar Thermal Collector

A solar thermal collector collects heat by absorbing sunlight. The term "solar collector" commonly refers to a device for solar hot water heating, but may refer to large power generating installations such as solar parabolic troughs and solar towers or non-water heating devices such as solar air heaters.

4. Working Principle of a SAHPD

Solar assisted heat pump dryer is under the classification of indirect solar drying; whereas, two combined technologies used together or separately to produce hot air or water. The thermal solar collector acts as a heat source, and the heat produced to feed the thermal pump evaporator is used. The objective of this system is to obtain high COP and then produce energy in a more efficient and less expensive manner.

5. SAHPD of Selected Agricultural Products

Solar assisted heat pump dryer used for many products including in marine and agriculture

industries. The selected agricultural of current review is rice, mushroom, cassava, banana, mango, red chilli, corn grain, coriander, dill, Indian gooseberry and orthosiphon stamineus.

5.1. Rice

A SAHPD connected with fluidized bed and biomass furnace to dry rice was developed in Indonesia by M. Yahya et al. [40]. The system consists of a flat plate collector with fins, fluidized bed, air-source blower, cyclone, biomass furnace, and heat pump, as shown in Fig. 2. The performance of the drying system and economic analyses have been studied. The content of the moisture was decreased from 32.850 % to 16.290 % (dry basis) in almost 23 minutes with a flow rate of mass equal to 0.1037 kg/sec at an average relative humidity of 8.14 % while keeping the average temperature at 81 °C. The improvement potential was found between 223.3 W and 1391.2 W, with an average value of 630.6 W. For the economic analyses, the payback period of the system was nearly 1.6 years.

5.2. Mushroom

The unique SAHP system for drying Mushroom in Turkey was designed and tested experimentally by Sevik et al. [41]. The drying system consists of three water-based flat plate collectors, heat exchangers, heat pump, axial fans and dryer filter, as displayed in Fig. 3. The coefficients of performance of the drying system (COP) was found to be from 2.1 to 3.1. Drying air temperature ranges from 45 °C to 55 °C is used to dry the Mushrooms at 0.086 kg/sec mass flow rate. The initial moisture content of the Mushroom was 13.24 g before reducing to 0.07 g (dry basis). Heat pump, solar energy, and SAHP system were used to dry the Mushrooms at 3.6 hrs to 4 hrs. at 2.75 – 4.5 hrs and at 3 – 3.8 hrs respectively. The specific moisture extraction rate (SMER) was tested and found to vary between 0.26 kg/kWh and 0.92 kg/kWh.

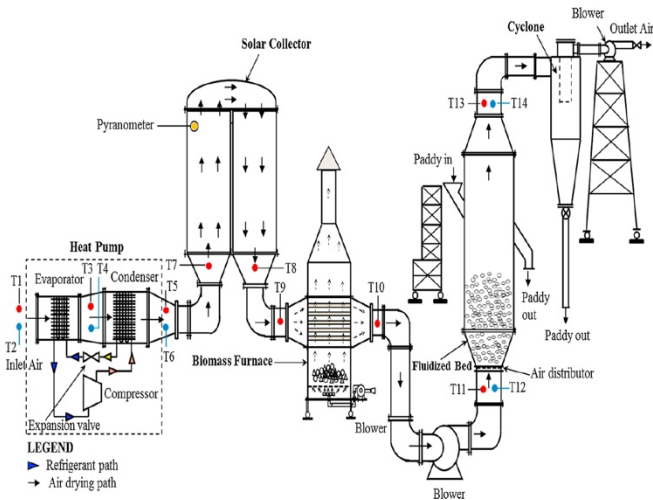

Figure 2. Schematic view of a SAHPD connected with fluidized bed and furnace of biomass for rice drying [40].

was gradually reduced from 61 % (wet basis) to 10.5 %, with an average flow rate of the mass of about 0.124 kg/sec. The SMER and average drying rate were 0.47 kg/kWh and 1930 g/h respectively.

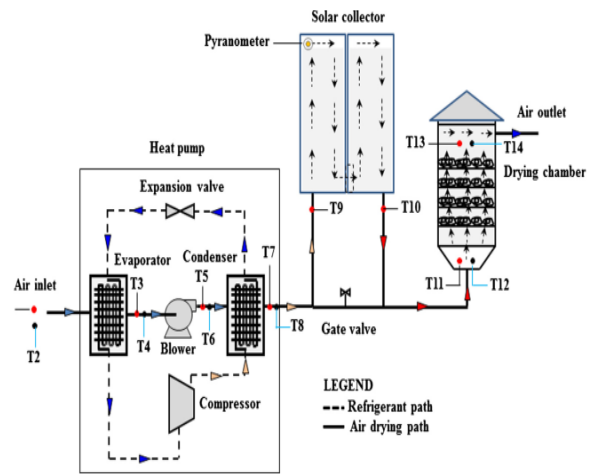

Figure 4. Schematic illustration of the solar-assisted heat pump system for cassava drying [42].

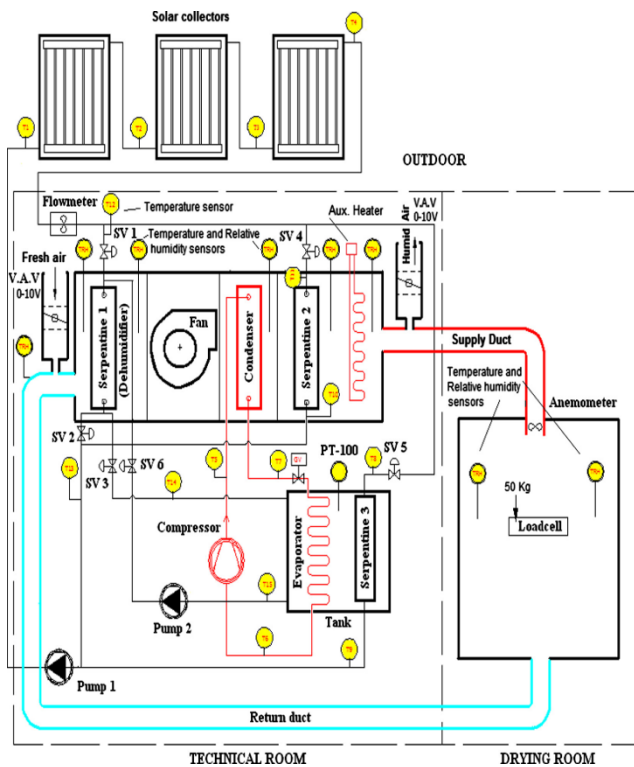

Figure 3. Schematic diagram of the solar-assisted heat pump system for mushrooms drying [41].

5.3. Cassava

A SAHP system for cassava drying in Indonesia was performed experimentally by M. Yahya et al. [42]. The drying system contains two finned flat plate collectors, air-source HP, drying chamber and blower as illustrated in Fig. 4. The cassava mass decreased from 30.8 kg to 17.4 kg for 9 hrs at an average temperature approximately equal to 45 °C. The content of moisture of cassava

5.4. Banana

Kuan et al. [43] examined numerically SAHP system to dry banana for continental climates. The system contains an air-based flat plate collector connected with HP and drying chamber as presented in Fig. 5. The coefficients of performance of the drying system were calculated to be 2.72. Inside the drying chamber, the temperature was changed between 48 °C and 52 °C in summer and between 42 °C and 44 °C during the winter climatic condition. The banana has an initial moisture content of about 74 % later reduced to 19 % (wet basis) in 21 hrs. The SMER was estimated mathematically to be equal to 0.6 kg/kWh.

5.5. Mango

Y. Wang et al. [44] developed a SAHP system for mango drying in China. The drying system divided into two principal subsystems: air source HP and solar drying components. The air collector of the evacuated tube is used in the solar drying component as illustrated in Fig. 6. The power consumption of the HP in the SAHP system mode was 3.5 kWh. Forty trays as a single layer were used for spreading 80 kg of mango for drying tests with the hot air nearly 45 °C. The mango slices (80 kg) were reduced down to 20 % (a wet basis)

within 6.5 hrs as well as the SMER of the mango was 2.05 kg/kWh.

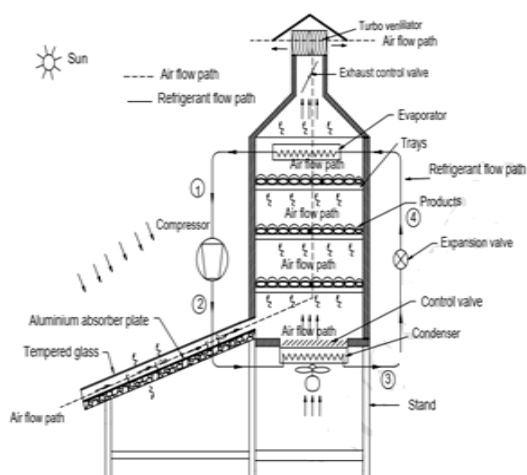

Figure 5. Schematic view of the solar-assisted heat pump system for banana drying [43].

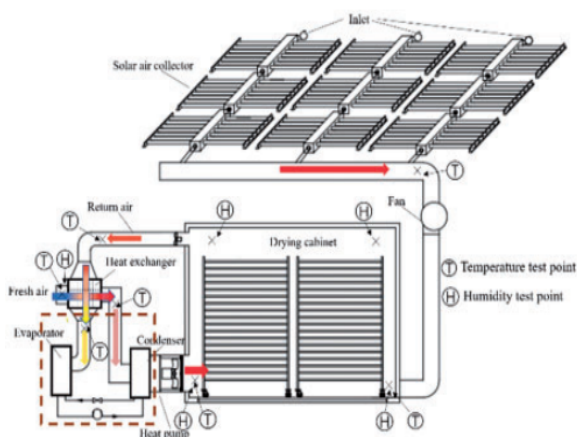

Figure 6. Schematic illustration of the SAHP system for mango slices drying [44].

5.6. Red Chilli

A SAHPD for chili drying in Vietnam was designed, manufactured and studied by Bui and Lê [45]. This system contains Air-based a flat plate collector, an HP, exhausted pipes and fan integrated with a drying chamber as shown in Fig. 7. Five kilograms of red chili was dried until its water content reached 11 %. The drying time approximately reached 7.5 hrs. Dezfouli et al. [46,47] designed, modified and tested solar assisted system for red chili drying in Malaysia. The system contains three main sub-systems such as the HP subsystem, a multi-functional solar

thermal collector as well as drying chamber as shown in Fig. 8. 15 kg of fresh Chili with initial moisture content 80 % (dry basis) were decreased to 10 % (wet basis) within 32 hrs. By compared between drying chili with the solar-assisted heat pump system and drying chili with the open sun, the authors concluded that drying chili by SAHPD has two-time saving time against of open sun method. M. Yahya [48] designed and evaluated SAHPD integrated with biomass furnace for red chili drying in Indonesia. The system consists of two air-based flat plate collectors, HP, biomass furnace, blower and drying chamber, as displayed in Fig. 9. The red chilies were dried from 22 kg with the initial moisture content of 4.26 and later reduced to 0.08 (dry basis) for 11 hrs.

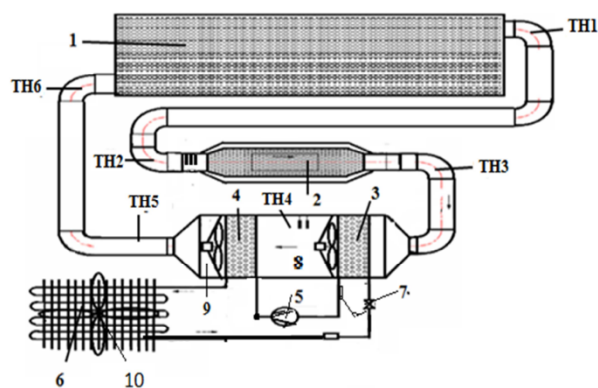

Figure 7. Schematic view of the solar-assisted heat pump dryer for chili drying in Vietnam [45].

5.7. Grain Corn

Y. Li et al [49] tested a SAHP system integrated with granary for grain drying. The drying system consists of a solar air collector, evaporator, air-source HP, air recycle tube, movable diaphragm, ventilation supply tube, condenser, granary, grain stirrer, and supply fan as shown in Fig. 10. The initial moisture content was varied and reached 4.7 %. The grain granary was classified into 5 layers and 24 points were chosen in every layer. The measurements of moisture content were recorded in each layer. The maximum moisture content recorded was 4.7 % according to 120 test samples and its content reduced to 2.8 %.

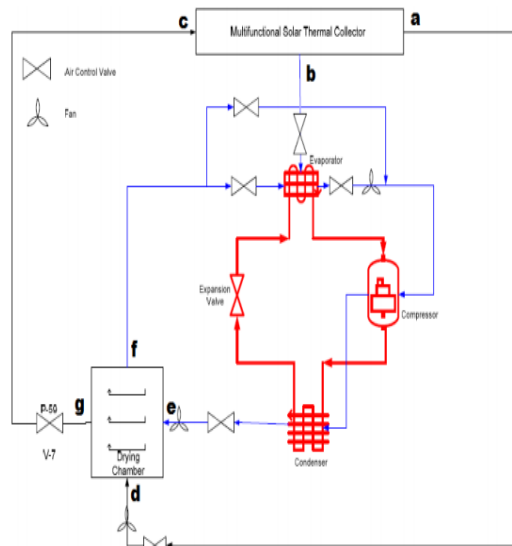

Figure 8. Schematic diagram of the SAHP system for chili drying in Malaysia [46,47].

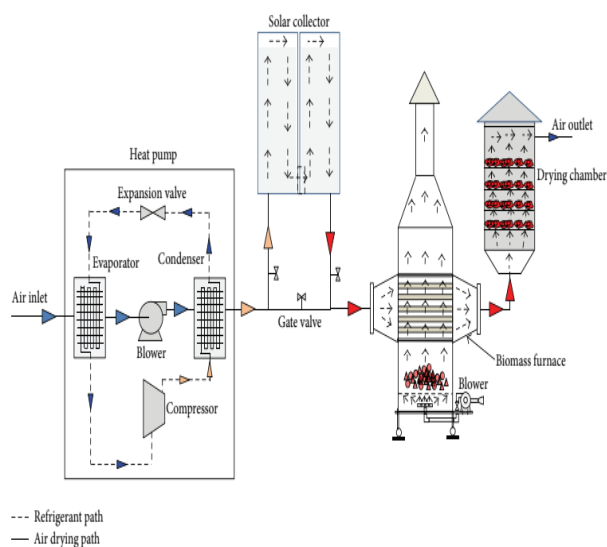

Figure 9. Schematic view of the SAHPD integrated with biomass furnace for red chili drying in Indonesia [48].

5.8. Coriander

Alishah et al. [50] constructed and installed a SAHPD in northern Iran for Coriander drying. The drying system contains two key components: the solar dryer and HP. The solar dryer consists of a solar flat plate collector and a circulation fan connected with the chamber (drying) and two auxiliaries electrical heaters as shown in Fig. 11. The moisture contents were varied between 0.9 to 0.1 kg/kg which were later reduced down up to 25 % at an average temperature equal 50 °C.

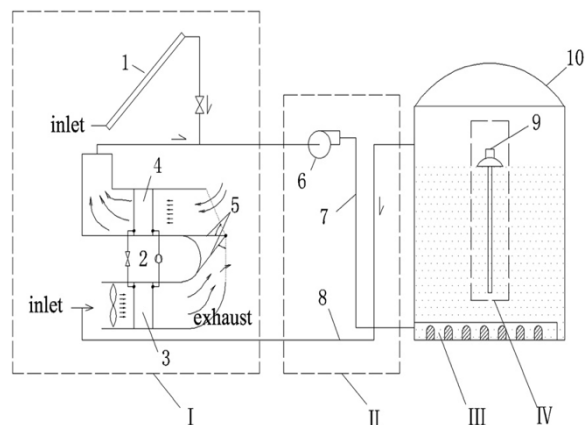

Figure 10. Schematic diagram of the solar-assisted heat pump system for grain drying [49].

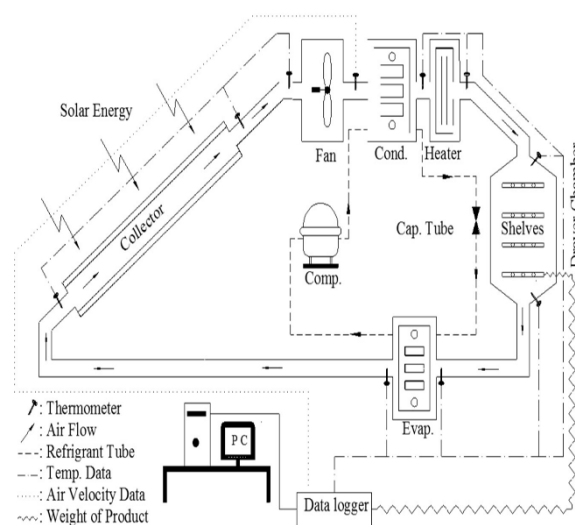

Figure 11. Schematic view of the SAHPD system for Coriander drying [50].

5.9. Dill

A SAHPD was developed and evaluated to dry the dill plant by in Iran by Jafarian et al. [51]. The drying system consists of an air-based flat plate solar collector, heat pump and fan connected with the drying chamber, as shown in Fig. 12. Dill was dried from the initial moisture content of 90 % were reduced to the final moisture content of 10 % in 1.33-2.33 hrs. at an average air temperature of 50 °C. The SMER varied from 0.078 to 0.18 kg/kWh.

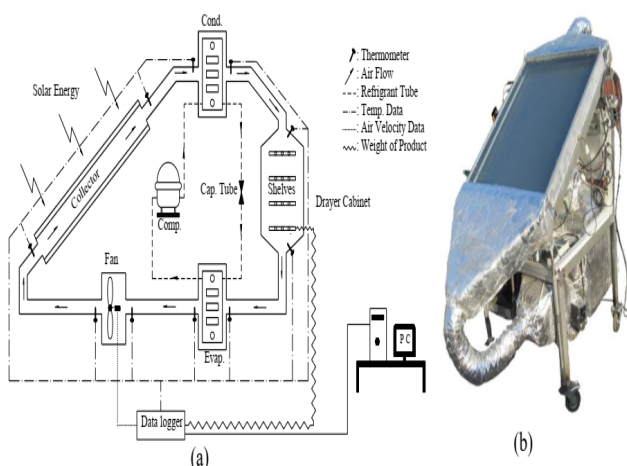

Figure 12. (a) Schematic diagram of SAHPD and (b) experimental set up of solar dryer [51].

5.10. *Indian Gooseberry*

P. Singh and S. Singh [52] developed and tested SAHP using a single-pass solar air heater for gooseberry drying. The system contains air source HP (dehumidifier), circulation fan, single-pass solar air heater, electrical backup and blower connected with the drying chamber as presented in Fig. 13. The capacity of the drying chamber is approximately 20 kg. The content of Vitamin-C in the SAHP dried gooseberry improved up to 88 % as compared to open sun drying. The drying time of gooseberry from the initial moisture content of 88.6 % to about 7 % (wet basis) at 50°C in 18 hrs as compared 8 – 10 days in the open sun drying was recorded.

5.11. *Orthosiphon Stamineus*

Orthosiphon stamineus has been studied from many aspects which are related to extraction of nanosilver [53], electronic sensing [54] and bioactive compound analysis [55]. S. H. Gan et al. [56] tested on open sun drying and HP for *orthosiphon stamineus*. The design and fabrication of the dryer contains an air source heat pump connected to the greenhouse drying chamber as presented in Fig. 14. The initial moisture content was approximately 78 % to 82 % (wet basis). The final moisture content targeted in the experiment ranges from 10 % to 12 % (dry basis). The testing was conducted in Malaysia, which experience approximately stable solar energy source [57] and was utilized to dry various samples including agricultural product [58,59,60].

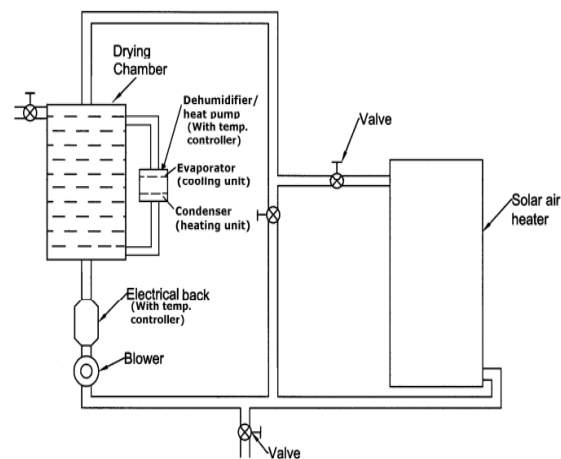

Figure 13. Schematic view of the SAHPD for Indian gooseberry drying [52].

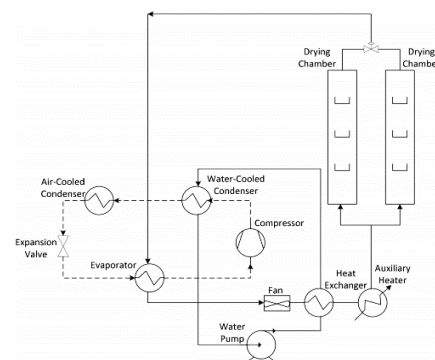

Figure 14. Schematic diagram of the open sun assisted heat pump dryer for *orthosiphon stamineus* drying [56].

Moreover, it is important to highlight the importance of research conducted to achieve net zero energy buildings [61], reduce peak energy consumption [62] and improve the processes of solar thermal systems [63-65].

6. **Conclusion**

Heat pumps (HP) provide a cost-efficient alternative to conventional heat recovery systems and can be implemented for various residential, commercial and industrial applications. Solar-assisted heat pumps (SAHP) are more sustainable and energy-efficient hybrid systems that can be used for water-heating, heat storage, and drying. (SAHPDs) were attractive methods of drying different agricultural products by utilizing solar energy as the source of heat. The addition of solar energy as a heat source for heat pump dryers leads to improvement in heat pump performance and energy efficiency which leads to two primary outcomes, firstly, dried product quality improvement and secondly, reduced the cost of

energy for drying the product. The novel designs of SAHPD were analyzed in terms of configuration and overall performance. This study provides a review of recent research and development studies, as well as the various aspects of SAHPD in the field. The work aimed to investigate the different components of heat pumps, solar thermal collector and SAHPD systems. Selected agricultural products dried with heat pumps were discussed and methods used for drying them were elaborated. The conclusions of the review are summarized in the following:

1. Heat pumps utilize less energy than other heating systems. Hence, they emit less harmful gases such as nitrogen oxides (NO_x) and carbon dioxide (CO₂) etc.
2. SAHP can utilize different solar energy technologies such as photovoltaic (PV) module, solar thermal collectors and hybrid PV/T units.
3. Solar irradiation varies throughout the day, which may reduce reliability, especially in rainy weather.
4. SAHPD requires higher capital costs for the installation of solar-related equipment (blowers, storage tanks, etc.).
5. SAHPD is better drying quality under well-control drying conditions, higher operating temperatures for drying and a smooth implementation control strategy.
6. SAHPD can be used in drying products like Rice, Mushroom, Cassava, Banana, Mango, red Chilli, Corn Grain, Coriander, Dill, Indian gooseberry, and Orthosiphon Stamineus.
7. Thermodynamic analysis and optimization of SAHPD is a favourable approach to reach optimal design parameters for the high efficiency of the thermodynamic cycle.

The need for further research and development on integrated SAHP and SAHPD systems into various applications is essential and this paper aims to raise awareness and encourage efforts towards it and elucidate the potential of these technologies by improving its design, performance, and sustainability.

7. Recommendation and Future Work

Various research studies have been investigated in this review to illustrate the concepts and design considerations of advanced SAHPD systems. We present the following recommendations, ideas, and concepts for future research studies:

1. To investigate the utility of solar collector/evaporated, which employs Phase Change Material (PCM) and nano-PCM for enhanced heat transfer and thermal efficiency in SAHPD systems.
2. To investigate the utility in coupling nano-PCM and nanofluid based PV/T systems with heat pump dryers.
3. To use electricity consumption and drying quality as evaluation criteria for comparing PV/T-assisted HPD and SAHPD.
4. To assess the quality of SAHPD output using prediction methods of Artificial Neural Networks (ANN).

Acknowledgements

The authors are grateful to all administrative staffs and research fellows of the Solar Energy Research Institute (SERI), Universiti Kebangsaan Malaysia and would like to acknowledge the provision of grant MRUN-RAKAN RU-2019-011/1 for supporting this work.

The authors also would like to thank Sebha University (Libya), Yanbu Industrial College (Kingdom of Saudi Arabia) and Universiti Malaysia Sabah (Malaysia) for supporting.

References

- [1] N. A. Ludin, N. I. Mustafa, M. M. Hanafiah, M. A. Ibrahim, M. A. M. Teridi, S. Sepeai, A. Zaharim and K. Sopian, "Prospects of life cycle assessment of renewable energy from solar photovoltaic technologies: a review," *Renewable and Sustainable Energy Reviews*, vol. 96, pp. 11-28, 2018.
- [2] H. A. Kazem, "Renewable energy in Oman: Status and future prospects," *Renewable and Sustainable Energy Reviews*, vol. 15, no. 8, pp. 3465-3469, 2011.
- [3] H. M. Al-Maamary, H. Kazem, and M. Chaichan, "Changing the Energy Profile of the GCC States: A Review," *International Journal of Applied Engineering Research (IJAER)*, vol. 11, no. 3, pp. 1980-1988, 2016.
- [4] J. Bundschuh and G. Chen, *Sustainable energy solutions in agriculture*. CRC Press, 2014.

- [5] B. C. Langley, Heat pump technology. Prentice Hall Upper Saddle River, 2002.
- [6] K. J. Chua, S. K. Chou, and W. Yang, "Advances in heat pump systems: A review," *Applied energy*, vol. 87, no. 12, pp. 3611-3624, 2010.
- [7] S. Chaturvedi, D. Chen, and A. Kheireddine, "Thermal performance of a variable capacity direct expansion solar-assisted heat pump," *Energy Conversion and management*, vol. 39, no. 3-4, pp. 181-191, 1998.
- [8] J. G. Cervantes and E. Torres-Reyes, "Experiments on a solar-assisted heat pump and an exergy analysis of the system," *Applied Thermal Engineering*, vol. 22, no. 12, pp. 1289-1297, 2002.
- [9] T. T. Chow, G. Pei, K. Fong, Z. Lin, A. Chan, and M. He, "Modeling and application of direct-expansion solar-assisted heat pump for water heating in subtropical Hong Kong," *Applied Energy*, vol. 87, no. 2, pp. 643-649, 2010.
- [10] H. Li and H. Yang, "Study on performance of solar assisted air source heat pump systems for hot water production in Hong Kong," *Applied Energy*, vol. 87, no. 9, pp. 2818-2825, 2010.
- [11] J.-Y. Long and D.-S. Zhu, "Numerical and experimental study on heat pump water heater with PCM for thermal storage," *Energy and Buildings*, vol. 40, no. 4, pp. 666-672, 2008.
- [12] R. Daghigh, M. H. Ruslan, M. Y. Sulaiman, and K. Sopian, "Review of solar assisted heat pump drying systems for agricultural and marine products," *Renewable and Sustainable Energy Reviews*, vol. 14, no. 9, pp. 2564-2579, 2010.
- [13] M. Hawlader, S. Chou, K. Jahangeer, S. Rahman, and E. L. KW, "Solar-assisted heat-pump dryer and water heater," *Applied Energy*, vol. 74, no. 1-2, pp. 185-193, 2003.
- [14] R. Best, W. Soto, I. Pilatowsky, and L. Gutierrez, "Evaluation of a rice drying system using a solar assisted heat pump," *Renewable energy*, vol. 5, no. 1-4, pp. 465-468, 1994.
- [15] M. Ibrahim, K. Sopian, W. Daud, M. Yahya, M. Alghoul, and A. Zaharim, "Performance predication of solar assisted chemical heat pump drying system in tropical region," in *2nd WSEAS/IASME International Conference on renewable energy Sources (RES'08) Corfu*, 2008, pp. 122-6.
- [16] J. T. J. Butler, "Drying peanuts with intermittent airflow," *Transactions of the ASAE*, vol. 23, no. 1, pp. 197-0199, 1980.
- [17] T. Maor and J. Appelbaum, "View factors of photovoltaic collector systems," *Solar Energy*, vol. 86, no. 6, pp. 1701-1708, 2012/06/01/ 2012.
- [18] M. A. Hasan and S. K. Parida, "An overview of solar photovoltaic panel modeling based on analytical and experimental viewpoint," *Renewable and Sustainable Energy Reviews*, vol. 60, pp. 75-83, 2016/07/01/ 2016.
- [19] J. Yazdanpanahi and F. Sarhaddi, "Irreversibility Rates in a Solar Photovoltaic/Thermal Water Collector: An Experimental Study," *Heat Transfer Research*, vol. 48, no. 8, 2017.
- [20] H. A. Hasan, K. Sopian, and A. Fudholi, "Photovoltaic thermal solar water collector designed with a jet collision system," *Energy*, vol. 161, pp. 412-424, 2018.
- [21] A. H. Al-Waeli, K. Sopian, H. A. Kazem, and M. T. Chaichan, "Photovoltaic Solar Thermal (PV/T) Collectors Past, Present and Future: A," *International Journal of Applied Engineering Research*, vol. 11, no. 22, pp. 10757-10765, 2016.
- [22] F. Calise, M. D. d'Accadia, R. D. Figaj, and L. Vanoli, "A novel solar-assisted heat pump driven by photovoltaic/thermal collectors: Dynamic simulation and thermoeconomic optimization," *Energy*, vol. 95, pp. 346-366, 2016.
- [23] M. Gholampour and M. Ameri, "Energy and exergy analyses of Photovoltaic/Thermal flat transpired collectors: Experimental and theoretical study," *Applied energy*, vol. 164, pp. 837-856, 2016.
- [24] M. E. A. Slimani, M. Amirat, I. Kurucz, S. Bahria, A. Hamidat, and W. B. Chaouch, "A detailed thermal-electrical model of three photovoltaic/thermal (PV/T) hybrid air collectors and photovoltaic (PV) module: Comparative study under Algiers climatic conditions," *Energy conversion and management*, vol. 133, pp. 458-476, 2017.
- [25] E. H. Kuzgunkaya and A. Hepbasli, "Exergetic performance assessment of a ground-source heat pump drying system," *International Journal of Energy Research*, vol. 31, no. 8, pp. 760-777, 2007.
- [26] S. Prasertsan, P. Saen-Saby, P. Ngamsritrakul, and G. Prateepchaikul, "Heat pump dryer Part 1: Simulation of the models," *International Journal of Energy Research*, vol. 20, no. 12, pp. 1067-1079, 1996.
- [27] J. A. Duffie, W. A. Beckman, and W. Worek, *Solar engineering of thermal processes*. Wiley Online Library, 2013.
- [28] W. Li, X. Ma, Z. Sun, Y. He, S. A. Sherif, J. Zhang and H. Zhu, "Evaporation heat transfer characteristics of R410A inside horizontal three-dimensional enhanced tubes," *International Journal of Thermal Sciences*, vol. 137, pp. 456-466, 2019.
- [29] A. Zendejboudi, A. Mota-Babiloni, P. Makhnatch, R. Saidur, and S. M. Sait, "Modeling and multi-objective optimization of an R450A vapor compression refrigeration system," *International Journal of Refrigeration*, vol. 100, pp. 141-155, 2019.
- [30] J. M. Mendoza-Miranda, A. Mota-Babiloni, and J. Navarro-Esbri, "Evaluation of R448A and R450A as low-GWP alternatives for R404A and R134a using a micro-fin tube evaporator model," *Applied Thermal Engineering*, vol. 98, pp. 330-339, 2016.
- [31] P. Makhnatch, A. Mota-Babiloni, A. López-Belchí, and R. Khodabandeh, "R450A and R513A as lower GWP mixtures for high ambient temperature countries:

- Experimental comparison with R134a," *Energy*, vol. 166, pp. 223-235, 2019/01/01/ 2019.
- [32] M. A. Kedzierski and D. Kang, "Horizontal convective boiling of R448A, R449A, and R452B within a micro-fin tube," *Science and technology for the built environment*, vol. 22, no. 8, pp. 1090-1103, 2016.
- [33] R. V. Ikhar and H. Farkade, "Evaluation of Vapour Compression Refrigeration System Using R407C and R507," *Evaluation of Vapour Compression Refrigeration System Using R407C and R507*, vol. 3, no. 4, 2017.
- [34] J. I. Hernandez, R. Roman, R. Best, R. Dorantes, and H. E. Gonzalez, "The Behavior of an Ejector Cooling System Operating with Refrigerant Blends 410A and 507," *Energy Procedia*, vol. 57, pp. 3021-3030, 2014/01/01/ 2014.
- [35] K. Takizawa, N. Igarashi, K. Tokuhashi, and S. Kondo, "Effects of temperature and pressure on quenching distances of difluoromethane (R32) and ammonia (R717)," *Science and Technology for the Built Environment*, vol. 24, no. 1, pp. 97-104, 2018.
- [36] M. S. Turgut and O. E. Turgut, "Comparative investigation and multi objective design optimization of R744/R717, R744/R134a and R744/R1234yf cascade refrigeration systems," *Heat and Mass Transfer*, vol. 55, no. 2, pp. 445-465, 2019.
- [37] C. Fan, G. Yan, and J. Yu, "Theoretical study on a modified heat pump cycle with zeotropic mixture R32/R290 for district heating in cold region," *Applied Thermal Engineering*, 2019.
- [38] W. Tang, G. He, S. Zhou, W. Sun, D. Cai, and F. Liu, "The experimental study of R290 mass distribution and indoor leakage of 2 HP and 3 HP split type household air conditioner," *International Journal of Refrigeration*, 2019.
- [39] H. Zhao, T. Yuan, J. Gao, X. Wang, and J. Yan, "Conventional and advanced exergy analysis of parallel and series compression-ejection hybrid refrigeration system for a household refrigerator with R290," *Energy*, vol. 166, pp. 845-861, 2019.
- [40] M. Yahya, H. Fahmi, A. Fudholi, and K. Sopian, "Performance and economic analyses on solar-assisted heat pump fluidised bed dryer integrated with biomass furnace for rice drying," *Solar Energy*, vol. 174, pp. 1058-1067, 2018/11/01/ 2018.
- [41] S. Şevik, M. Aktaş, H. Doğan, and S. Koçak, "Mushroom drying with solar assisted heat pump system," *Energy Conversion and Management*, vol. 72, pp. 171-178, 2013/08/01/ 2013.
- [42] M. Yahya, A. Fudholi, H. Hafizh, and K. Sopian, "Comparison of solar dryer and solar-assisted heat pump dryer for cassava," *Solar Energy*, vol. 136, pp. 606-613, 2016/10/15/ 2016.
- [43] M. Kuan, Y. Shakir, M. Mohanraj, Y. Belyayev, S. Jayaraj, and A. Kaltayev, "Numerical simulation of a heat pump assisted solar dryer for continental climates," *Renewable Energy*, vol. 143, pp. 214-225, 2019/12/01/ 2019.
- [44] Y. Wang, M. Li, Y. Qiu, Q. Yu, X. Luo, G. Li and X. Ma, "Performance analysis of a secondary heat recovery solar-assisted heat pump drying system for mango," *Energy Exploration & Exploitation*, p. 0144598718823937, 2019.
- [45] B. Q. Huy, "Experiment Investigation on a Solar Assisted Heat Pump Dryer for Chili," *International Journal of Energy and Environmental Science*, vol. 3, no. 1, p. 37, 2018.
- [46] M. Dezfouli, S. Mat, M. H. Ruslan, and K. Sopian, "Evaluation of drying chili by two methods: solar assisted heat pump dryer and open sun drying," in *Proceedings of the 1st International Conference on Environmental Informatics (ENINF'13)*, pp. 112-116.
- [47] Z. A. A. Majid, M. Y. Othman, M. H. Ruslan, S. Mat, B. Ali, A. Zaharim and K. Sopian, "Multifunctional solar thermal collector for heat pump application," in *Proceedings of the 3rd WSEAS int. conf. on renewable energy sources*, 2009, pp. 342-346.
- [48] M. Yahya, "Design and performance evaluation of a solar assisted heat pump dryer integrated with biomass furnace for red chilli," *International Journal of Photoenergy*, vol. 2016, 2016.
- [49] Y. Li, H. F. Li, Y. J. Dai, S. F. Gao, Lei Wei, Z. L. Li, I. G. Odinez and R. Z. Wang, "Experimental investigation on a solar assisted heat pump in-store drying system," *Applied Thermal Engineering*, vol. 31, no. 10, pp. 1718-1724, 2011.
- [50] A. Alishah, M. V. Kiamahalleh, F. Yousefi, A. Emami, and M. V. Kiamahalleh, "Solar-Assisted Heat Pump Drying of Coriander: An Experimental Investigation," *International Journal of Air-Conditioning and Refrigeration*, vol.26, no.4, p.1850037, 2018.
- [51] H. Jafarian, K. R. Tabatabaei, and S. S. Mousavi, "Experimental Investigation on Dill Drying in a Solar-Assisted Heat Pump Dryer," 2017.
- [52] P. Singh and S. Singh, "Amla (*Emblica officinalis*) Drying in Solar-assisted Heat Pump Dryer," *International Energy Journal*, vol. 12, no. 4, 2012.
- [53] M. A. M. Ariff, R. Alrozi, M. H. Saleh, N. A. Razak, M. S. Osman, N. A. Zamanhuri, "Green biosynthesis of nanosilvers using aqueous extract from *Orthosiphon stamineus* leaves", *IEEE Symposium on Humanities, Science and Engineering Research*, 2012.
- [54] N. Z. I. Zakaria, M. J. Masnan, A. Y. M. Shakaff, A. Zakaria, L. M. Kamarudin, N. Yusuf and A.H.A. Aziz, "Electronic flavour assessment techniques for *Orthosiphon stamineus* tea from different manufacturers", *IEEE Conference on Wireless Sensor (ICWISE)*, 2013.
- [55] S. Jumali, M. E. Ya'acob, R. Shamsudin and N. F. Othman, "Field assessment for photovoltaic array as herbal plots based on bioactive compounds analysis", *IEEE Industrial Electronics and Applications Conference (IEACon)*, 2016.
- [56] S. H. Gan, M. X. Ng, T. C. Tham, L. S. Chua, R. Aziz, M. R. Baba, L. C. Abdullah, S. P. Ong & C. L. Law, "Drying characteristics of *Orthosiphon stamineus* Benth by solar-

assisted heat pump drying," *Drying technology*, vol. 35, no. 14, pp. 1755-1764, 2017.

[57] K. Sukarno, A. S. A. Hamid, J. Dayou, M. Z. H. Makmud and M. S. Sarjadi, "Measurement of Global Solar Radiation in Kota Kinabalu Malaysia", *ARPN Journal of Engineering and Applied Sciences*, vol.10, no.15, p.6467-6471, 2015.

[58] A. S. A. Hamid, A. Ibrahim, S. Mat and K. Sopian, "Experimental Evaluation on Large Scale Solar Dryer for Drying Natural Fiber in Malaysia", *International Journal of Renewable Energy Research IJRER*, vol.9, no.2, p.598-604, 2019.

[59] A. N. Iskandar and M. E. Ya'acob, "Temperature performance of a 3-tier solar PV drying chamber," *IEEE Industrial Electronics and Applications Conference (IEACon)*, Kota Kinabalu, pp. 112-115, 2016.

[60] M. M. Rahman, A. G. M. M. Billah, S. Mekhilef and S. Rahman, "Application of Genetic Algorithm for optimization of solar powered drying," *IEEE Innovative Smart Grid Technologies - Asia (ISGT ASIA)*, Kuala Lumpur, pp. 647-651, 2014.

[61] Annuk, Andres, Erkki Jõgi, Mart Hovi, Mairo Märss, Jaanus Uiga, Hardi Hõimoja, Tõnis Peets, Janar Kalder, Algirdas Jasinskis, and Alo Allik. "Increasing self electricity

consumption by using double water heating tanks for residential net zero-energy buildings." In *2017 IEEE 6th International Conference on Renewable Energy Research and Applications (ICRERA)*, pp. 106-110. IEEE, 2017.

[62] Keskin, İlhan, and Gurkan Soykan. "Reduction of peak power consumption by using photovoltaic panels in Turkey." In *2017 IEEE 6th International Conference on Renewable Energy Research and Applications (ICRERA)*, pp. 886-890. IEEE, 2017.

[63] Msomi, Velaphi, and Ouisin Nemraoui. "Improvement of the performance of solar water heater based on nanotechnology." In *2017 IEEE 6th International Conference on Renewable Energy Research and Applications (ICRERA)*, pp. 524-527. IEEE, 2017.

[64] Yoshida, Yusuke, and Yuzuru Ueda. "Verification of consumer's benefits for different area ratio of PV array and solar thermal water heater considering regional characteristics." In *2015 International Conference on Renewable Energy Research and Applications (ICRERA)*, pp. 472-477. IEEE, 2015.

[65] Naranjo-Mendoza, C., Daniel R. Rouse, and G. Quesada. "Modeling of a solar absorption cooling system for Guayaquil, Ecuador." In *2013 International Conference on Renewable Energy Research and Applications (ICRERA)*, pp. 853-856. IEEE, 2013.